



MOISTURE-RESISTANT HOMES

A Best Practice Guide and Plan Review Tool for Builders and Designers
With a Supplemental Guide for Homeowners

MOISTURE-RESISTANT HOMES

U.S. Department of Housing and Urban Development
Office of Policy Development and Research



PATH (Partnership for Advancing Technology in Housing) is a new private/public effort to develop, demonstrate, and gain widespread market acceptance for the “Next Generation” of American housing. Through the use of new or innovative technologies, the goal of PATH is to improve the quality, durability, environmental efficiency, and affordability of tomorrow’s homes.

PATH is managed and supported by the U.S. Department of Housing and Urban Development (HUD). In addition, all federal agencies that engage in housing research and technology development are PATH partners, including the Departments of Energy, Commerce, and Agriculture, as well as the Environmental Protection Agency (EPA) and the Federal Emergency Management Agency (FEMA). State and local governments and other participants from the public sector are also partners in PATH. Product manufacturers, home builders, insurance companies, and lenders represent private industry in the PATH Partnership.

To learn more about PATH, please contact



451 7th Street, SW
Washington, DC 20410
202-708-4277 (phone)
202-708-5873 (fax)
email: pathnet@pathnet.org
website: www.pathnet.org

Visit PD&R’s Web site

www.huduser.org

to find this report and others sponsored by
HUD’s Office of Policy Development and Research (PD&R).

Other services of HUD USER, PD&R’s Research and Information Service, include listservs; special interest, bimonthly publications (best practices, significant studies from other sources); access to public use databases; and a hotline 1–800–245–2691 for help accessing the information you need.

Moisture-Resistant Homes

A Best Practice Guide and Plan Review Tool
for Builders and Designers

With a Supplemental Guide for Homeowners

Prepared for:

**U.S. Department of Housing and Urban Development
Office of Policy Development and Research
Washington, DC**

Prepared by:

**Newport Partners LLC
Davidsonville, MD**

March 2006

About the Authors

This report was prepared by Newport Partners LLC and Applied Residential Engineering Services (ARES). Newport Partners provides analytical, technical, regulatory, and market research services to clients in the building industry, with an emphasis on building performance analysis and the integration of innovative building systems. ARES provides engineering and consulting services related to building science research, forensics, building code development, efficient materials and construction methods, and the implementation of innovative technology.

Acknowledgements

This guide draws upon many building industry resources to synthesize the best practices and techniques provided in this publication. Groups such as the U.S. Department of Housing and Urban Development (HUD) and its Partnership for Advancing Technology in Housing (PATH) program, the U.S. Department of Energy (DOE), the Canadian Mortgage and Housing Corporation (CHMC), the Institute for Business and Home Safety (IBHS), Building Science Corporation, APA – The Engineered Wood Association (APA), the Energy and Environmental Building Association (EEBA), and many others listed throughout this guide have all produced useful guidance on building durable homes that manage moisture. Steven Winter Associates produced the figures and graphics for the guide. Terry Brennan of Camroden Associates, Jeffrey R. Gordon of the Building Research Council/School of Architecture at the University of Illinois at Urbana/Champaign, and Barry Steffen of HUD's Office of Policy Development provided review for the guide. Their review provided valuable insights on moisture management in houses, but does not imply an endorsement of this publication or its contents. Finally, the authors also acknowledge Michael Blanford of HUD's Office of Policy Development and Research for his thoughtful oversight and support of this project.

Disclaimer

While the information in this document is believed to be accurate, the authors, reviewers, contributors, and the U.S. Department of Housing and Urban Development do not make any warranty, guarantee, or representation, expressed or implied, with respect to the accuracy, effectiveness, or usefulness of any information, method, or material in this document, nor do they assume any liability for the use of any information, methods, or materials disclosed herein or for damages arising from such use. Users of this information are encouraged to secure professional advice for specific design and construction issues. Further, any references to specific products are provided solely as examples and are not endorsements of the product.

Foreword

The proper design and construction of homes and other buildings has always involved attention to moisture control. While this originated with the straightforward need to keep moisture out and protect the structure from deterioration, in recent years the issue has become much more complex and occupants' expectations have risen. Moisture control now includes the challenge of managing interior moisture, including water vapor, in order to promote occupant comfort, protect indoor air quality, and prevent the development of mold.

As the federal agency most directly concerned with housing and related issues, HUD's perspective on moisture control and management has also evolved over time. This document addresses issues that fall under the jurisdiction of two offices within HUD: the Office of Policy Development and Research (PD&R), and the Office of Healthy Homes and Lead Hazard Control (OHHLHC). PD&R has worked for years to develop improved methods for constructing affordable, durable homes, while OHHLHC concentrates on protecting indoor housing environments from potential threats to occupant health and safety. This guidebook represents a valuable compilation of technical guidance advancing the interests of both offices.

At a time when consumers demand better performance from their homes than ever before, absolute moisture protection for houses is a most demanding goal. At the same time our understanding of more subtle issues related to the effects of moisture and proper control continues to evolve. As a result, while good moisture control ultimately rests on scientific principles, it also must be implemented by home builders and remodelers who bring a more practical orientation to the construction process. To encourage successful implementation, the recommendations in this guide have been designed to combine the latest technical knowledge with more traditional elements of judgment, experience and common sense. Success in this process will not only advance the interests of PD&R and OHHLHC, it will also benefit the home building industry and, most important of all, the present and future occupants of housing throughout the country.



Darlene F. Williams
Assistant Secretary for Policy
Development and Research



Jon L. Gant
Director
Office of Healthy Homes and
Lead Hazard Control

Summary of Recommendations

ROOF AND CEILING SYSTEMS

- Evaluate roof pitch and material properties when selecting roof coverings. (p. 4)
- Apply bituminous adhesive taping on sheathing joints, use appropriately rated roof coverings, and fasten coverings per manufacturer instructions in high wind areas. (p. 7)
- Use hail-rated shingles and remove old shingles (when re-roofing) in hail-prone regions. (p. 8)
- Avoid concentrated or obstructed roof drainage pathways. (p. 8)
- Minimize roof penetrations by using selected plumbing and HVAC technologies. (p. 8)
- Specify flashing details for roofs, including kick-out flashing and other details, and incorporate in roofing contracts. (p. 10)
- Design roof ventilation based on climate and insulation amount to prevent ice dams. (p. 16)
- Size eave and rake roof overhangs based on climate. (p. 20)
- Design a properly sized roof drainage system including gutter sizing, downspout sizing and downspout placement, based on roof pitch and local rainfall intensity. (p. 21)

WALL SYSTEMS

- Consider a drained cavity weather-resistant envelope (WRE) system for most non-severe climates and building exposures, or select alternative WRE approach based on climate, site condition and target performance level. (p. 24)
- Follow manufacturer's installation guidelines for windows and doors. (p. 33)
- Field test repetitive installations on large projects. (p. 33)
- Understand how windows and doors are designed to manage water. (p. 33)
- Use third-party certified windows and doors. (p. 34)
- Specify and verify wind pressure and impact resistance performance ratings for windows. (p. 34)
- Specify flashing details for all windows, doors, and ledgers. (p. 37)
- Supplement standard flashing details for additional protection against severe weather. (p. 40)
- Specify and use appropriate sealants and installation practices for particular applications. (p. 45)

FOUNDATIONS

Site Planning and Foundation Design

- Create a workable site drainage plan prior to construction. (p. 46)
- Provide a finished grade away from the foundation greater than the minimum (6" in 10') to offset backfill settlement. (p. 49)
- Use a simple screening process to assess sites for moisture and drainage concerns. (p. 49)

Basement Foundations and Basement Walls

- Include foundation backfill specifications on plans and in foundation contractor agreement. (p. 51)
- Waterproof exterior walls of basements used for storage or living space. (p. 52)
- Install horizontal reinforcement at top and bottom of foundation walls to control cracks. (p. 52)
- Design basement insulation and finishes to dry towards the interior, especially where traditional finish practices (e.g. warm-in-winter vapor retarder) have resulted in moisture problems. (p. 54)
- Use semi-permeable rigid foam insulation between the foundation wall and finished basement walls when using a basement finish system that dries to the interior. (p. 54)
- Prevent warm, humid indoor basement air from leaking into finish wall and ceiling assemblies. (p. 54)
- Separate basement wall finishes from the basement floor slab. (p. 56)

Slab on Grade

- Provide a mounded foundation pad to achieve 8" minimum clearance above exterior finish grade. (p. 57)
- Use a sub-slab vapor retarder directly below slabs with a capillary break layer beneath the vapor retarder. (p. 57)
- Provide for concrete slab crack control with wire or fiber reinforcement and control joints. (p. 57)
- Install horizontal rebar as reinforcement to reduce foundation cracking. (p. 59)
- Apply slab foundation insulation on the foundation exterior of slab on grade foundations. (p. 59)
- Use moisture resistant finishes on new slabs where feasible. (p. 60)
- Use slab insulation strategies when moisture sensitive finishes will be applied. (p. 60)
- Account for top-of-slab vapor control before finishing existing slabs that do not have a sub-slab vapor barrier. (p. 60)

Crawl Spaces

- Provide a lapped ground cover for all crawlspace foundations. (p. 62)
- Provide foundation drainage and damp-proofing for crawlspaces that are below exterior grade. (p. 62)
- Evaluate vented and non-vented (particularly for hot/humid climates) crawlspace ventilation strategies. (p. 63)

Wood Framing

- Maintain minimum 8" clearances to protect wood from ground moisture. (p. 64)
- Match the treatment level of preserved wood to the application and exposure. (p. 67)
- Store all treated wood in a protected, ventilated space before use. (p. 69)

WATER VAPOR CONTROL

Controlling Indoor Humidity

- Provide increased whole-house and spot ventilation with dry outdoor air and add ventilation controls that automate spot exhaust when interior RH levels are a concern. (p. 74)
- Protect building materials from exposure during storage and construction. (p. 75)
- Moisture test wetted building assemblies during the construction process prior to close-in. (p. 75)
- Properly size cooling equipment based on house characteristics and climate to improve water vapor removal. (p. 76)
- Educate occupants on the RH impacts of homeowner habits. (p. 76)

Controlling Air Leakage

- Consider the impacts on water vapor movement and water shedding that result from air barrier materials. (p. 77)
- Seal major air leakage points such as attic hatches, mechanical chases and penetrations, and floor overhangs. (p. 77)
- For cathedral roofs, focus carefully on sealing all air leakage points into the ceiling cavity. (p. 78)
- Use an interior air barrier system in cold and very cold climates. (p. 80)
- Use an air barrier system on the outside of the wall in moist/humid climates. (p. 80)

Vapor Retarders

- In hot/humid climates exterior wall systems should dry towards the interior by locating vapor retarding materials on the **outside** of the wall assembly and keeping interior materials vapor permeable. (p. 83)
- Educate homeowners in hot/humid regions not to limit the ability of walls to dry towards the interior by adding non-breathable interior finishes on exterior walls. (p. 84)
- In cold climates exterior wall systems should dry towards the outside by locating vapor retarding materials on the **inside** of the wall assembly and keeping exterior materials vapor permeable. (p. 84)

MECHANICAL SYSTEMS

- Size cooling systems with a house-specific load calculation using Manual J or a comparable tool. (p. 85)
- Upgrade to variable capacity H/P or A/C to improve moisture removal. (p. 85)
- Provide supplemental dehumidification to control indoor humidity in humid regions. (p. 86)
- Use sealed combustion HVAC equipment. (p. 87)
- Seal ducts to ≤ 5.0 CFM25/100 ft² to reduce air leakage and moisture movement. (p. 87)
- Design adequate return air pathways using multiple returns or jumper ducts and transfer grilles. (p. 87)
- Provide whole-house mechanical ventilation appropriate for the climate. (p. 88)
- Terminate all exhaust vents outdoors with appropriate through-wall or through-roof components. (p. 89)
- Use exhaust duct runs that are as straight as possible and less than 25' in length. (p. 89)

Table of Contents

- PART I - GENERAL 1**
 - 1.1 Introduction..... 1
 - 1.2 Scope and Approach..... 1
 - 1.3 How to Use the Guide..... 2
- PART II - BUILDING PLANNING & DESIGN PHASE..... 3**
 - 2.1 General Approach..... 3
 - 2.2 Best Practices for Moisture-Resistant Roof Systems..... 3
 - 2.2.1 Roof Coverings for Typical Steep-slope Roofs 3
 - 2.2.2 Roof Flashing..... 10
 - 2.2.3 Roof Ventilation and Insulation 15
 - 2.2.4 Roof Overhangs and Projections 19
 - 2.3 Best Practices for Moisture-Resistant Wall Systems..... 24
 - 2.3.1 Weather-Resistant Exterior Wall Envelope 24
 - 2.3.2 Window & Door Components..... 32
 - 2.3.3 Flashing of Wall Components 36
 - 2.3.4 Caulks and Sealants 44
 - 2.4 Best Practices for Moisture-Resistant Foundations 45
 - 2.4.1 Site Planning & Foundation Design Considerations 45
 - 2.4.2 Basement Foundation Construction..... 48
 - 2.4.3 Basement Wall Insulating & Finishing..... 53
 - 2.4.4 Slab on Grade Construction 56
 - 2.4.5 Concrete Slab on Grade Insulation and Finishes 60
 - 2.4.6 Crawlspace Construction 62
 - 2.4.7 Ground Clearances for Wood Protection 64
 - 2.4.8 Preservative Treatments for Wood Protection 66
 - 2.4.9 Alternative Foundation Construction Methods 69

(continued)

2.5 Best Practices for Moisture Vapor Control	70
2.5.1 General	70
2.5.2 Climate Considerations.....	70
2.5.3 Overview of Moisture Vapor Problems.....	72
2.5.4 Controlling Indoor Humidity.....	74
2.5.5 Controlling Air Leakage.....	76
2.5.6 Vapor Retarders.....	82
2.5.7 Mechanical Systems	84
PART III – CONSTRUCTION PHASE.....	91
PART IV – HOMEOWNER GUIDE TO WATER MANAGEMENT & DAMAGE PREVENTION..	93
4.1 Introduction	93
4.2 Moisture Control Background for Homeowners	94
4.3 Moisture Problems: Prevention and Correction	97
4.3.1 What to Look for In the Kitchen.....	97
4.3.2 What to Look for in the Bathroom	99
4.3.3 What to Look for in the Utility Room	100
4.3.4 What to Look for in the Attic	103
4.3.5 What to Look for in the Basement	104
4.3.6 What to Look for in the Laundry Room	106
4.3.7 What to Look for Outside Your Home	107
4.3.8 What to Look for on the Roof	109
4.3.9 Dealing With Major Water Damage Events.....	110
4.3.10 What To Do After a Natural Disaster	110
4.4 In Conclusion	112

List of Figures

Figure 1 - Double Layered Roofing Underlayment	5
Figure 2 - Hail Day Map of United States	7
Figure 3 - Typical Roof Drainage Problems to Avoid	9
Figure 4 - Basic Roof Flashing (Shingle Roof)	11
Figure 5 - Valley Flashing (Shingle Roof)	12
Figure 6 - Eave Ice Dam Flashing.....	13
Figure 7 - End Dam (Kick-out) Flashing	14
Figure 8 - Roof Ventilation Configurations.....	18
Figure 9 - Roof Overhangs.....	19
Figure 10 - Decay Hazard Index Map	20
Figure 11 - Rainfall Intensity Map of the United States	22
Figure 12 - Roof Drainage Design Example	23
Figure 13 - Illustration of WRE Systems.....	25
Figure 14 - Wind-driven Rain Map of the United States	28
Figure 15 - Moisture Index for North America.....	29
Figure 16 - Potential Window Unit Leakage Paths	35
Figure 17 - Basic Window Flashing	38
Figure 18 - Window Sill and Jamb Flashing.....	39
Figure 19 - Window Flashing for Severe Weather	40
Figure 20 - Deck Ledger Flashing Detail	41
Figure 21 - Typical Brick Veneer Flashing Details	42
Figure 22 - Brick Veneer Flashing at Roof Intersections	43
Figure 23 - Site Drainage Plan Considerations (Single Lot)	47
Figure 24 - Basement Foundation Detail	50
Figure 25 - Moisture-Resistant Basement Wall Finishes	55
Figure 26 - Slab on Grade Construction.....	58
Figure 27 - Moisture Resistant Slab on Grade Floor Finishes and Details	61
Figure 28 - Details to Separate Wood from Ground Moisture	65
Figure 29 - Heating Degree Day Map	71
Figure 30 - Decay Hazard Index Map	72
Figure 31 - Condensation Zone Map.....	73
Figure 32 - Big Air Leakage Points to Seal.....	79
Figure 33 - Air Barrier System Approaches and Important Features	81

List of Tables

Table 1 - Roof Covering Selection Data	4
Table 2 - Eave Ice Dam Flashing Widths (inches)	13
Table 3 - Minimum Roof Ventilation Requirements	16
Table 4 - Recommended Roof Ventilation Levels to Prevent Chronic Ice Dams	17
Table 5 - Recommended Minimum Roof Overhang Width	19
Table 6 - Maximum Allowable Tributary Roof Plan Area	23
Table 7 - Building Exposure Levels	30
Table 8 - Relative Performance of WRE Approaches	31
Table 9 - Caulk Characteristics and Application Recommendations	44
Table 10 - Use Categories for Treated Softwood Lumber & Plywood	67
Table 11 - Levels of Preservative Treatment for Southern Pine	68
Table 12 - Quality Management Recommendations	92

PART I - GENERAL

1.1 Introduction

This guide advances the goal of designing, building, and maintaining houses that manage moisture effectively. As with any goal, moisture-resistant housing requires decisions – decisions by designers, decisions by builders, decisions by remodelers, decisions by trades, and decisions by homeowners. Therefore, this guide is a resource for good decision making in applying moisture management best practices.

By making moisture-resistant best practices available in an easy-to-use form, a variety of the most common moisture-related problems in homes can be avoided. These problems include rain penetration, structural decay, mold growth, high indoor humidity, condensation, wet foundations, ice dams, and many others that are well known to builders, homeowners, and insurers. For the most part, these problems are preventable or controllable, but only if timely decisions are made and acted upon. While Benjamin Franklin’s advice that “an ounce of prevention is worth a pound of cure” was originally focused on preventing fires, it applies equally well to preventing moisture problems in homes.

Drawing from practical experience and the best available technical resources, this guide assembles proven, state-of-the-art moisture management best practices. These practices address topics directly related to moisture control – like window flashing – as well as less obvious issues that still influence the behavior of water in a house, like the moisture

implications of duct leakage. *The application of these practices will provide a home with multiple lines of defense against moisture, so that as a home ages or certain details begin to fail, the overall structure will still manage moisture effectively.* Also, many of the best practices featured in this guide are tailored for important site-specific factors, such as climate or decay hazards that may vary widely around the U.S.

Finally, good moisture management involves a degree of uncertainty in regard to judgment as well as scientific knowledge. *And because the best practices in this guide are faced with this challenge, they should not be construed as absolutes. Equally effective or better alternatives are possible and encouraged.* This guide is meant to promote forward thinking - not stifle it with “one-size-fits-all” solutions. And most importantly - if you are specifically trying to address or prevent moisture problems, you have already made the most important “best practice” decision.

1.2 Scope and Approach

This tool was developed with the following important end-users in mind: designers, builders, remodelers, and homeowners. The scope of the document is focused on relatively common moisture issues encountered in one- and two-family dwellings (attached and detached). The featured best practices are intended to address these issues in typical light-frame wood construction using common building systems. The

1.3 How to Use the Guide

practices deal with direct moisture issues as well as related design concerns that also influence moisture management in a house. Many of the best practices will provide multiple layers of protection against moisture (e.g., roof overhangs + window flashing), which is an intentional approach to providing good long-term performance.

Also, given the diversity of housing materials and construction styles in the U.S., ***the general approach within the guide is to present moisture management ideas that can lead to several viable solutions, rather than specifying a single workable solution that assumes the use of a limited selection of materials and details.*** In sections where a single detail is provided, additional details or variations may also provide workable solutions. This approach gives designers and builders the flexibility to develop tailored solutions that reflect their material choices, design preferences, and strategies for meeting various code requirements.

1.3 How to Use the Guide

This document is organized by three key phases of the building construction process: Planning and Design, Construction, and Delivery. The Planning and Design phase - Part II of the guide - is the most critical, as this is where moisture management decisions are made and implemented on building plans. Most of the best practices associated with different design considerations are found in Part II. The Construction phase, covered by Part III of the guide, focuses on the *implementation* of best practice decisions made in Part II. Part IV of the guide provides background information and inspection and maintenance tips for the homeowner when the final product - a moisture-resistant new

or remodeled home - is delivered. This section of the guide is written as a stand-alone section such that it can be provided to homeowners independently.

In terms of the format, key recommendations and highlighted points in the document are noted in ***blue, italicized text***. Also, numerous text boxes which provide auxiliary information to the main discussion are found throughout the text.

A few suggestions on how this guide can be used:

For a quick overall summary of the best practice recommendations, readers are encouraged to review the up-front Summary of Recommendations found on page iii. These short summaries are organized by building system, and can give an overview of dozens of practices in just a few minutes. Each best practice summary is referenced to a page number, so that readers can easily go deeper for more information on a topic.

To review part or all of a house design for its moisture resistance, readers can review the sub-chapters of Part II to assess their design and consider possible enhancements. Part II offers best practice guidance in the area of roofs, wall systems, foundations, and moisture vapor control.

For simple steps to implement good moisture management practices in the field, readers can reference Part III of the guide. This section offers a concise checklist of jobsite quality management steps that can convert good design intentions into as-built realities.

And finally, ***for a better understanding of the actions which homeowners should take to protect their houses from moisture***, readers are referred to Part IV of the guide.

PART II - BUILDING PLANNING & DESIGN PHASE

2.1 General Approach

The focus of Part II is on the designer or persons responsible for making design decisions and incorporating them into building plans and other construction documents.

It is assumed that a code-compliant building plan exists and that this guide is being used to review and enhance the building plan with selected best practices.

Alternatively, the best practices may be incorporated or considered earlier during the planning and design process, which may help to avoid potential conflicts with other important design considerations, such as architectural preferences, structural components, or energy code requirements. A few of the best practices found below may be consistent with minimum building code requirements, but most others intentionally go beyond code minimums.

For each major building system Part II provides a set of design considerations and best practice recommendations. For example, if a foundation cross-section and related plan notes are being reviewed for moisture performance; useful best practice information can be found in the Foundations section within the discussions of design considerations like “Basement Wall Insulating & Finishing.” Thus, particular parts of a plan can be quickly reviewed and red-lined to include moisture-related best practices. Issues concerning moisture vapor tend to overlap building systems, and as such they are discussed in individual sections – like walls – as well as in a comprehensive section that deals with the systems interactions of vapor-related problems.

2.2 Best Practices for Moisture-Resistant Roof Systems

2.2.1 Roof Coverings for Typical Steep-slope Roofs

OBJECTIVES: Roof coverings provide a first line of defense against the elements. They also tend to be the most exposed component of a building’s exterior envelope. Therefore, roof coverings should be selected, detailed, and installed to provide durable resistance to water penetration. Because more than three-quarters of all homes use composition roof shingles, this type of product receives the most attention in this section.

This design consideration deals with selecting and using a reasonably durable and weather-resistant roof covering. These considerations are intended to enhance or help fulfill the objectives for a roof installation as found in the 2003 International Residential Code (IRC) which states:

R903.1 General. Roof decks shall be covered with approved roof coverings secured to the building or structureRoof assemblies shall be designed and installed in accordance with this code and the approved manufacturer’s installation instructions such that the roof assembly shall serve to protect the building or structure.

Building codes don’t address many of the details required for a complete and proper

2.2.1 Roof Coverings for Typical Steep-slope Roofs

Table 1 - Roof Covering Selection Data

Roof Covering Types	Minimum Roof Pitch ^a	Weight ^b (lbs per sf)	Service Life ^c (yrs)
Composition Shingle	2:12 ^a	2 to 4	15 to 30
Wood Shingle	3:12	3 to 4	15 to 30
Metal (standing seam)	1/4 :12	1 to 3	20 to 50+
Concrete/Clay Tile	2 1/2:12 ^a	9 to 25	50+
Slate	4:12	9+	50 to 100
Built-up Roof	1/4 :12	6	12 to 30
Synthetic Membrane Roof	1/4 :12	1	20+

Table Notes:

- A minimum roof pitch of 4:12 is allowable with normal use of single-layer roofing underlayment. However, a minimum 2:12 roof pitch is permissible for composition shingles provided that 15# tarred felt underlayment is doubled. Similarly, a 2 1/2:12 roof pitch is permissible with concrete/clay tile provided that 30# tarred felt or mineral surfaced roll roofing is similarly doubled. See Figure 1.
- Weights are approximate, refer to manufacturer data.
- Service life may vary widely from these estimates due to differences in local climate, installation practice and conditions at the time of installation, product variations, maintenance history, and others. Estimates are based on Life Expectancy of Housing Components, 1993.

installation of the many available roofing products. Therefore, the statement regarding “in accordance with ... manufacturer’s installation instructions” should not be taken lightly! Industry standard installation guidelines are also important resources.

PRECAUTIONS: Objective data that quantify the performance differences between various roof coverings is fairly limited. And while cost generally increases with increased performance and durability, higher cost products may not offer performance or life expectancy benefits proportional to their higher price.

BEST PRACTICES:

Evaluate Roof Pitch and Material Properties when Selecting Roof Coverings

While roof covering selection is primarily driven by first cost, local custom, and

aesthetics, other factors should weigh into this decision. These include roof pitch, weight, service life, and special use conditions. Table 1 and the following discussion compare these factors for different roof coverings.

Minimum Roof Pitch – Steep-slope roof systems are defined by the National Roofing Contractors Association (NRCA) as systems designed for installation on slopes greater than 3:12 (14 degrees). Steep-slope roofs are water-shedding, not waterproof. Therefore, roof pitch is limited in accordance with Table 1 for various steep slope roofing products. To prevent water leaks, these roof systems rely on fast drainage, adequate overlapping of elements, and use of underlayment as a back-up layer of protection. For composition shingles and concrete/clay tiles, Figure 1 shows a double underlayment detail to be used on slopes less than 4:12 for these two roof coverings (see Table 1, Note 1).

2.2.1 Roof Coverings for Typical Steep-slope Roofs

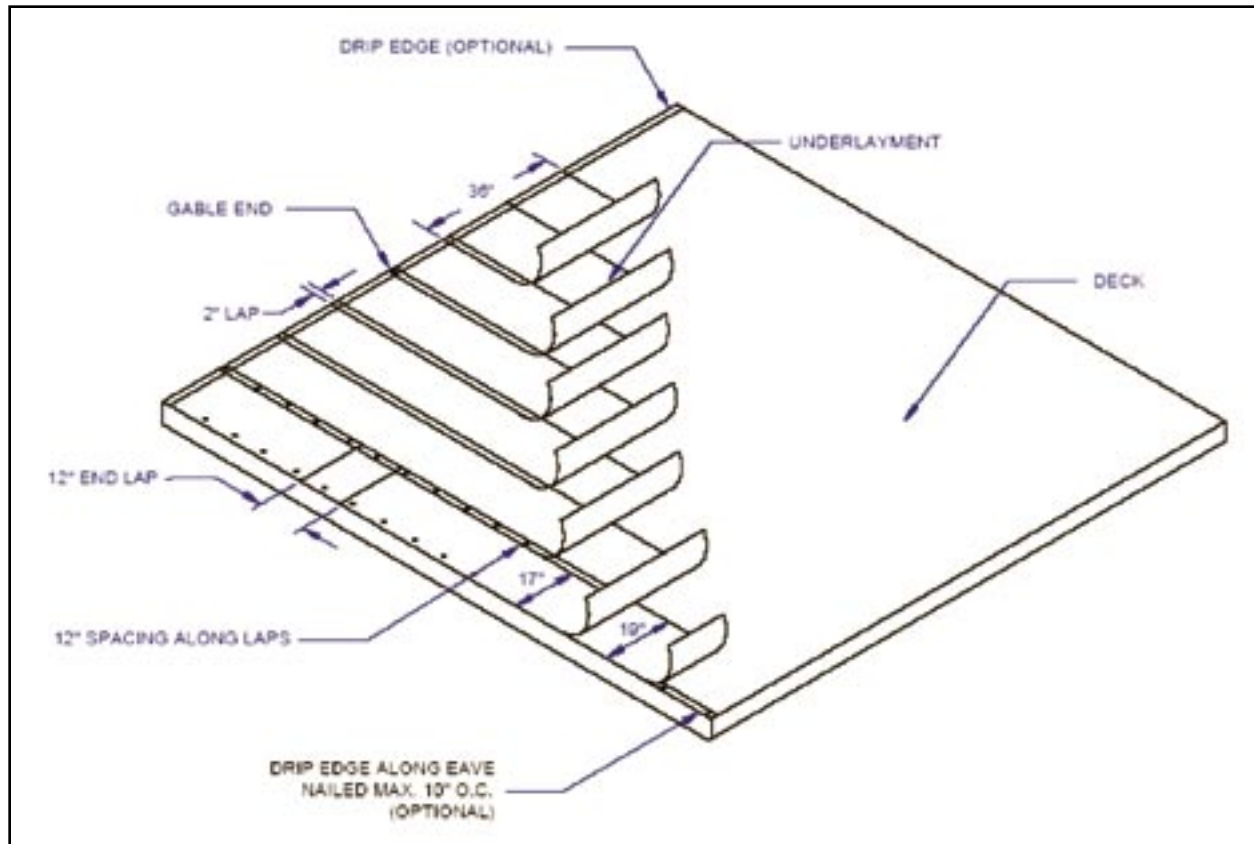

Figure 1 - Double Layered Roofing Underlayment
(for composition shingle roof and tile roof with pitch less than 4:12)

Optimizing Slope of a Water-Shedding Roof

Considering several factors, a moderate roof pitch (e.g., 4:12 to 7:12) provides a favorable balance of pros and cons for water-shedding roof systems. For example, lower roof pitches will tend to decrease drainage efficiency, allow debris to accumulate, and increase wind uplift loads on the roof. In addition, as the roof ages or becomes damaged, leaks are likely to be more severe. While very steep roof pitches will tend to increase drainage efficiency, they increase the building and roof's exposure to lateral wind loads. Furthermore, water flow velocity will be increased (particularly at valleys) which may cause scour, accelerated wear, and over-shooting of gutters. Also, very steep slope roofs are more difficult and less safe to access for construction, maintenance, and replacement. Designing an attic for usable space will also introduce other considerations related to roof slope.

2.2.1 Roof Coverings for Typical Steep-slope Roofs

Considerations for Low-Slope Roofs & Special Applications

Low slope and special roof covering applications require special attention to material selection, plan detailing, and construction management. When in doubt, help should be sought from roofing experts or the technical support resources of the manufacturer. For example, a waterproof membrane for a balcony or deck surface may be desired. The surface will need to be wear-resistant as well as waterproof. In addition, the surface must drain a minimum of ¼":12" toward the balcony or deck perimeter or internal drains. Flashing must be carefully detailed at intersections with building walls and membrane penetrations. In addition, some low-slope roof applications may require special design of drainage features such as drain inlets, scuppers, and emergency overflow outlets to prevent ponding of water due to extreme rainfall events or sagging of roof members due to snow load. Beware that many of these design requirements may be found in the commercial building plumbing code rather than the residential building code. As a result of these design and installation considerations, some membrane roofing manufacturers require their products to be installed by their own network of certified installers.

By contrast, low-slope systems are designed as waterproof roof systems, and use roof coverings designed for pitches of as low as ¼:12. While low-slope roofs are commonly known as "flat roofs", a dead flat roof surface is a design mistake.

Weight – The weight of the roof covering must be considered in the design of the roof, although it is not directly related to a moisture management concern. Most homes are designed for a maximum roof covering weight of no more than 5 psf (pounds per square foot). When replacing the roof on an existing home, a structural analysis should be performed if a light roof covering is being replaced by a much heavier roof covering.

Service Life – The service life estimates in Table 1 are rough approximations designed to inform an initial decision on roof covering. For a more thorough estimate of service life considerations, the reader is referred to an automated web-based durability assessment tool, known as "Durability Doctor." This tool was created by the National Institute for Standards and Technology (NIST) under HUD's Partnership for Advancing Technology in Housing (PATH) program and is hosted on the PATH website (www.pathnet.org).

Use Wind-Resistant Roofing in High Wind Areas

When specified and installed properly, many roofing systems will provide adequate performance in high wind regions. However, there are a few items deserving special attention:

Wind Ratings – Be sure the product is rated for the local design wind speed. *For example, in areas subject to hurricane force winds, asphalt composition shingles should be labeled as meeting the ASTM D3161 test for a 110 mph wind speed rather than the standard 60 mph test. This is required in newer model building codes like the 2003 IRC.*

Fastening – *Follow manufacturer installation instructions and be sure that fasteners are properly installed* (e.g., appropriate fastener spacing, fasteners installed without damaging material, etc.). In general, 6 roofing nails per shingle rather than the standard 4 nails are required for composition shingles in high wind regions. Ensure that roofing fasteners are not over-driven (e.g., the head damages or tears the shingle) to avoid complete loss of shingle strips – a major cause of extensive water damage to contents of homes during severe

2.2.1 Roof Coverings for Typical Steep-slope Roofs

wind-driven rain events. Attention to fastening quality is equally important for other roofing materials such as tile and metal.

Underlayment – Typical 15# tarred felt underlayment provides back-up protection against water intrusion only as long as the primary roofing material remains intact. It is not intended for direct exposure in the event of loss of the primary roofing system in a severe wind-driven rain event. To enhance protection against water intrusion and damage to the building and contents in severe wind-driven rain climates, ***continuously apply bituminous adhesive tape to sheathing joints prior to installing the underlayment.***

This practice provides a level of protection against water intrusion, even in the event of severe primary roofing damage from wind. For further back-up protection, a self-adhering bituminous membrane may be applied to the entire roof.

Flashing – Longer than normal flashing overlaps and vertical legs should be used in anticipation of severe wind-driven rain and wind pressure (see Section 2.2.2 for flashing concept details). Roof edge flashing should be securely attached to substrate.

Roof Sheathing – The roof covering is only as strong as the substrate to which it is attached.

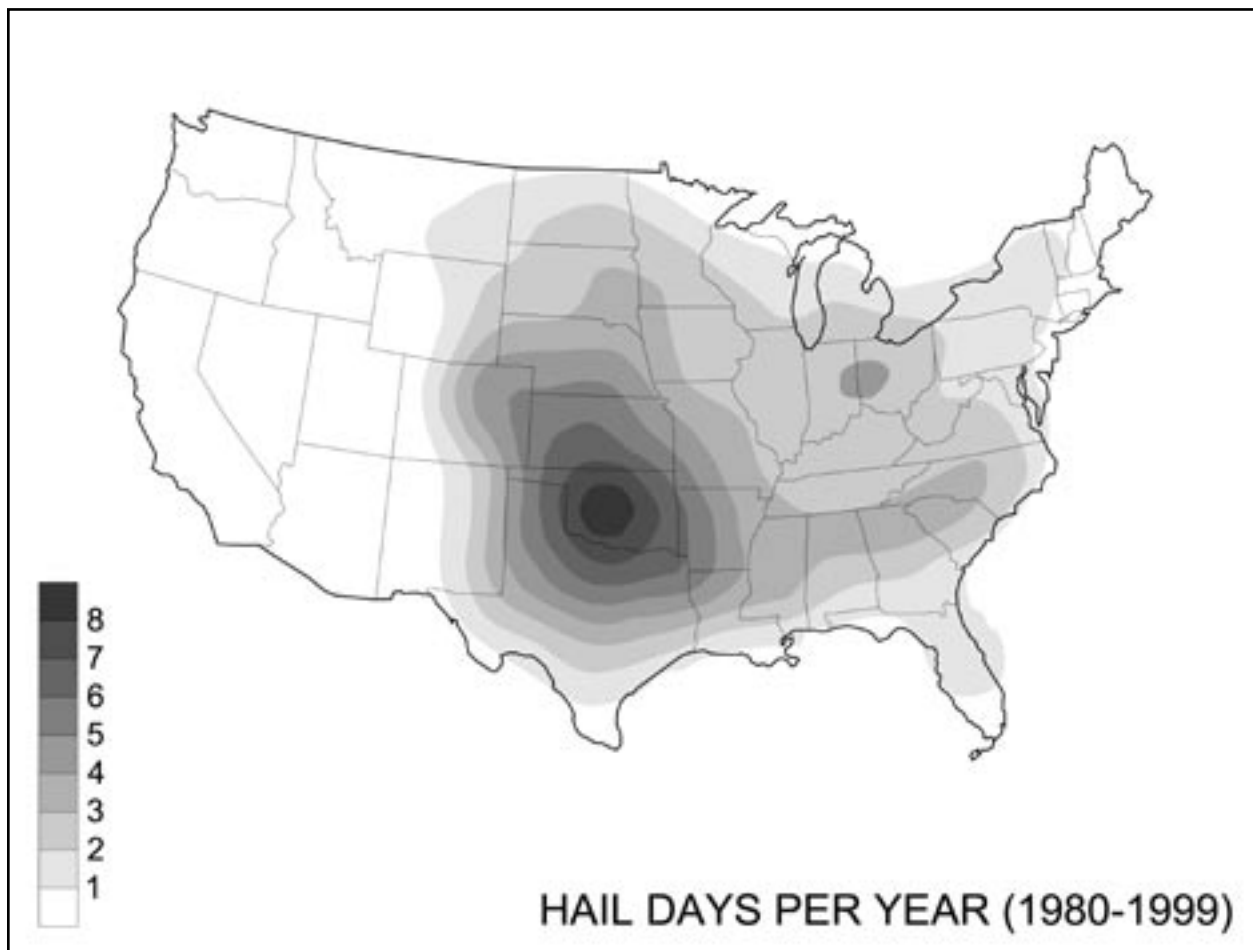

Figure 2 - Hail Day Map of United States
Source: NOAA National Severe Storms Laboratory

2.2.1 Roof Coverings for Typical Steep-slope Roofs

Be sure to inspect for proper installation of roof sheathing before the underlayment and roofing go on. Because underlayment is sometimes installed by the framing contractor immediately after completion of roof sheathing, a timely inspection is critical. Roof sheathing in high wind areas should be attached with minimum 8d (0.113" diameter) deformed shank nails or 8d common nails (0.131" diameter) spaced 6 inches on center at all framing members. Full-round head or D-head nails should be specified and should not be over-driven into or through the sheathing as this severely weakens the connection.

Roofing and Re-roofing for Hail Damage Protection

Composition shingles rated for hail resistance or other more resistant roofing products should be considered for hail damage protection. Since hail can occur in so many parts of the country at least occasionally, the stronger the likelihood of hail, the more seriously enhanced shingles should be considered. The hail days map shown in Figure 2 is presented as an example, and illustrates the mean number of days per year with a hail event that is damaging and/or has hail of at least 3/4" in diameter. Maps and indexes found in building codes should be referenced when available.

Composition shingles tested in accordance with UL 2218 and rated as "Class 4" (classes range from a low of 1 to a high of 4) may be used for improved hail resistance. In some states like Texas, hail damage insurance premiums may be reduced with the use of impact resistant roofing. In fact, as of October 2004 the Texas Department of Insurance provided an online listing of manufacturers of products that meet the state's roofing discount requirements (www.tdi.state.tx.us/commish/roofingx.html).

Another consideration for protecting roofs from hail damage involves re-roofing. Re-roofing over an existing layer of composition shingles, while generally permitted by code, reduces the ability of the newer shingles to resist impact damage from hail. **Therefore, in hail-prone regions the insurance industry recommends and local code may require that re-roofing should include removal of the existing layer(s) of old composition shingle roofing.**

Avoid Concentrated or Obstructed Roof Drainage

In modern construction, adding complexity to roof plans is commonly done to improve curb appeal. But adding complexity to the roof drainage system can also create long-term moisture problems. A balance is needed so roof rainwater flows aren't excessively concentrated or obstructed as shown in Figure 3. If these conditions cannot be avoided, then affected regions of the roof should be adequately detailed and waterproofed, and guttering should be appropriately designed to channel water off the roof and away from the building.

Minimize Roof Penetrations

Roof penetrations increase the likelihood of water leaks due to failed gaskets, sealants, and flashing. The number of roof penetrations may be reduced by a variety of technologies and strategies, including:

- air admittance valves (AAVs) to reduce or eliminate plumbing vent stack penetrations
- consolidation of vent stacks below the roof
- exhaust fan caps routed through walls instead of the roof

2.2.1 Roof Coverings for Typical Steep-slope Roofs

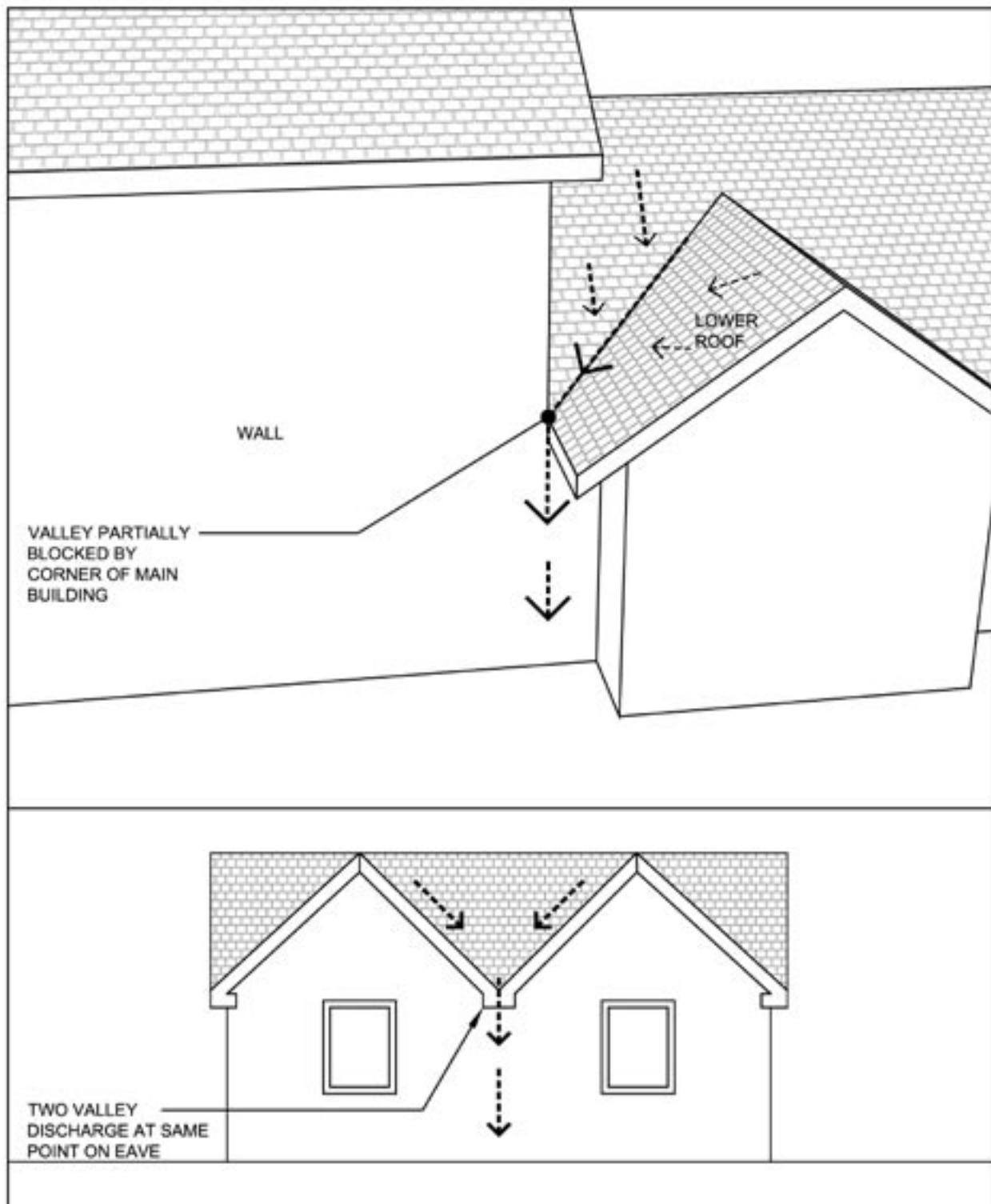

Figure 3 - Typical Roof Drainage Problems to Avoid

- high-efficiency combustion appliances which can be sidewall vented
- electrically powered HVAC equipment and hot water heaters that do not require flue pipes

In addition to providing minimized penetrations, these techniques can also result in significant labor and material savings, especially for roof coverings like clay tile or metal.

REFERENCES AND ADDITIONAL RESOURCES

Ahluwalia, G. and Shackford, A., “Life Expectancy of Housing Components”, *Housing Economics*, National Association of Home Builders, Washington DC, August 1993

Asphalt Roofing Manufacturers Association, www.asphaltroofing.org

International Residential Code (IRC), International Code Council, Inc., Falls Church VA, 2003, www.iccsafe.org

Manual on Moisture Control in Buildings (ASTM Manual 18), Chapter 16—General Considerations for Roofs by Wayne Tobiasson, American Society of Testing and Materials, West Conshohocken PA, 1994, www.astm.org

National Roofing Contractors Association, www.nrca.net

Partnership for Advancing Technology in Housing, www.pathnet.org, a public-private initiative dedicated to accelerating the development and use of technologies that radically improve the quality, durability, energy efficiency, environmental performance, and affordability of America’s housing

RCI-Mercury (www.rci-mercury.com), a dynamic, searchable online library that includes technical, historical, and innovative roofing and waterproofing information

2.2.2 Roof Flashing

OBJECTIVES: Water penetration is commonly associated with flashing and detailing problems around roof penetrations, eaves, and wall intersections with a lower roof section. The following best practice provides recommended flashing details for common applications in residential construction and presents basic concepts to use in other applications. These conceptual details are intended to enhance or help fulfill the basic objective for roof flashing as found in the 2003 IRC:

R903.2 Flashing. Flashings shall be installed in such a manner so as to prevent moisture entering the wall and roof through joints in copings, through moisture permeable materials, and at intersections with parapet walls and other penetrations through the roof plane.

PRECAUTIONS: Model U.S. building codes only provide basic performance concepts for use and detailing of flashing. Therefore, it is imperative that designers and builders consider this issue as a key element of construction plan detailing, construction trade coordination, and field quality control. Manufacturer recommendations and industry standard flashing installation guidelines provide a valuable resource.

BEST PRACTICE:

Specify Flashing Details for Roofs

Figures 4 through 7 provide models for correct flashing installation techniques for asphalt composition shingle roofing – the most common roofing material used in residential construction. For flashing details for other roofing types, refer to manufacturer literature and industry guidelines.

To avoid roof leaks, appropriate flashing details should be used wherever possible

2.2.2 Roof Flashing

BEST PRACTICES ILLUSTRATED:

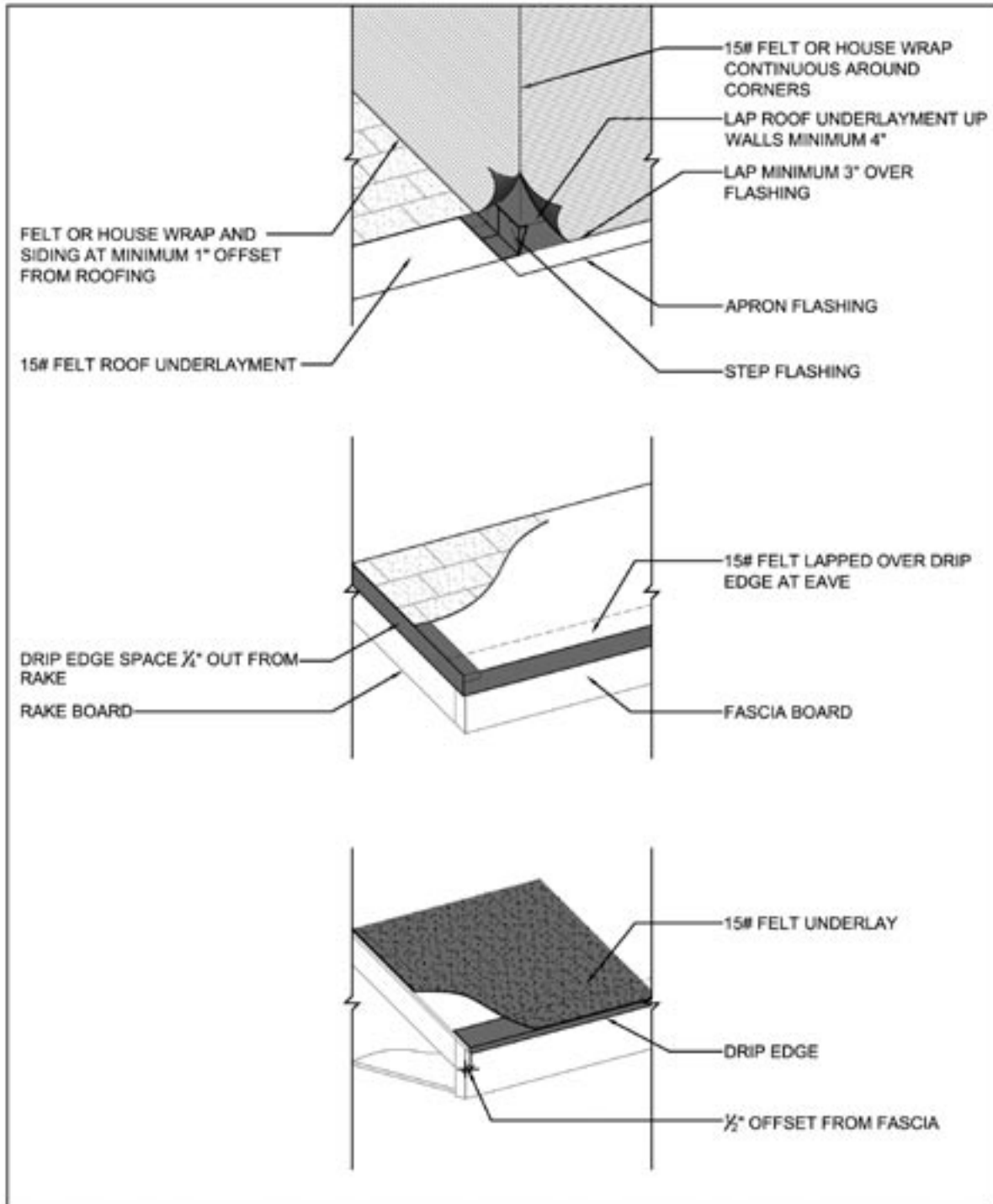

Figure 4 - Basic Roof Flashing (Shingle Roof)

2.2.2 Roof Flashing

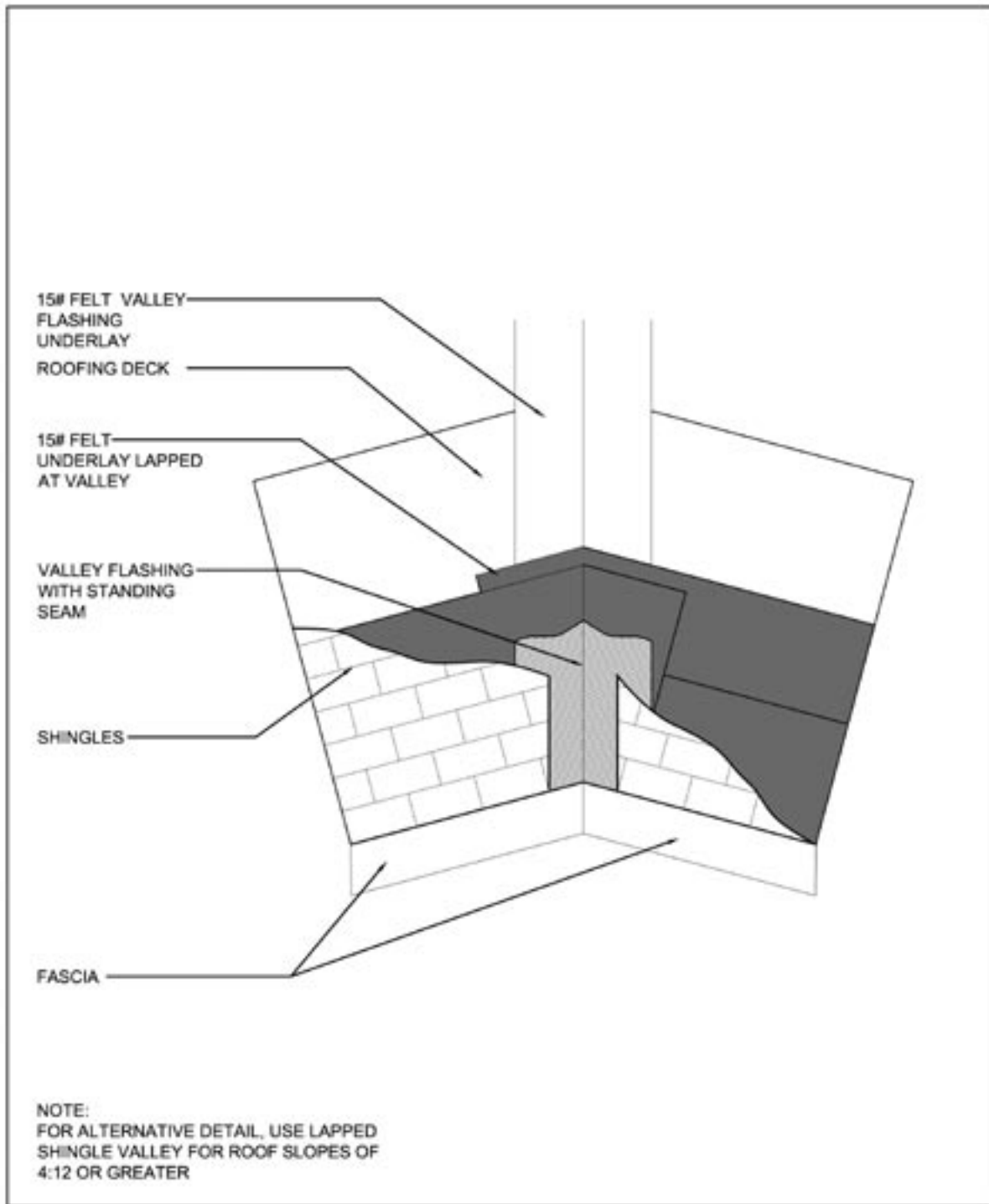

Figure 5 - Valley Flashing (Shingle Roof)

2.2.2 Roof Flashing

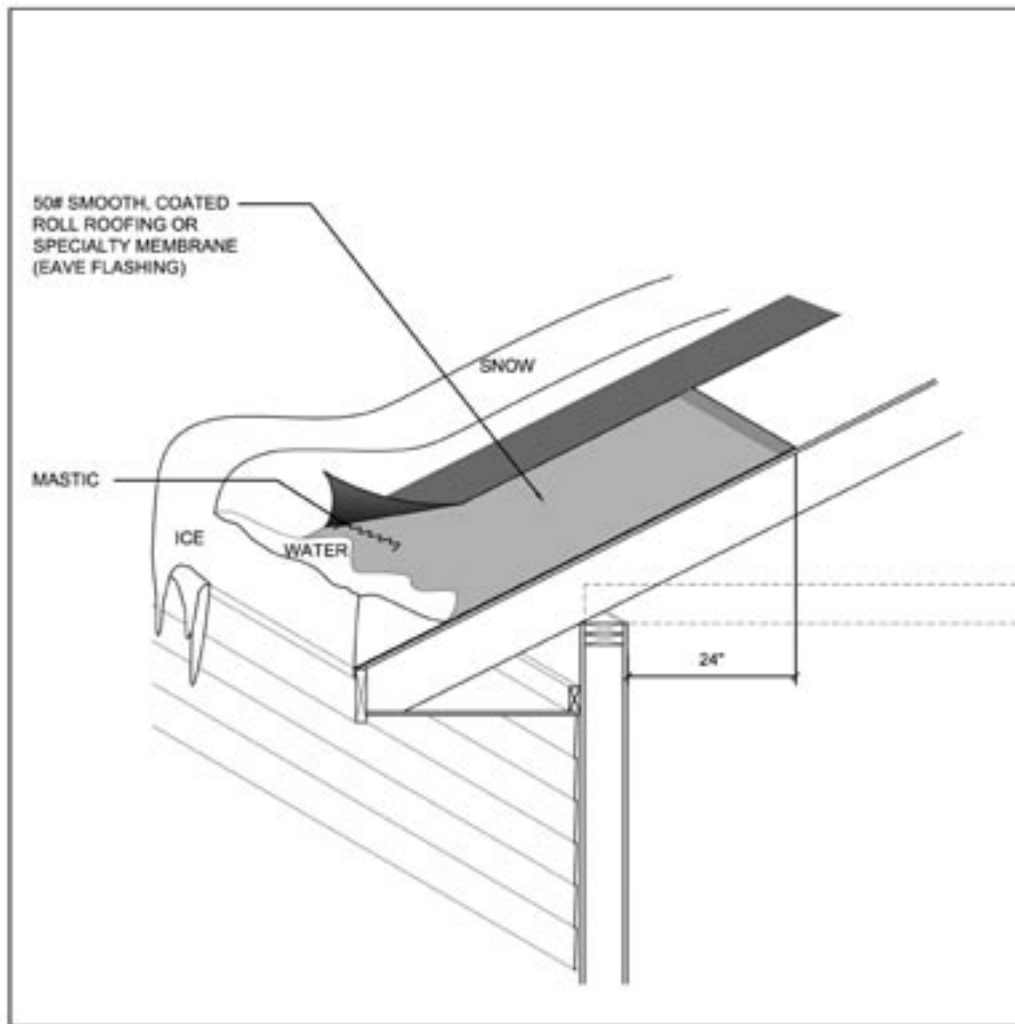

Figure 6 - Eave Ice Dam Flashing
*(Applies to climates with ground snow load of 20 psf or greater
 or in areas with known ice dam hazards)*

Table 2 - Eave Ice Dam Flashing Widths (inches)

Eave Overhang (inches)	Roof Slope					
	4:12	5:12	6:12	7:12	8:12	9:12
8	34	35	36	37	38	40
12	38	39	40	42	43	45
16	42	43	45	46	48	50
24	51	52	54	56	58	60

2.2.2 Roof Flashing

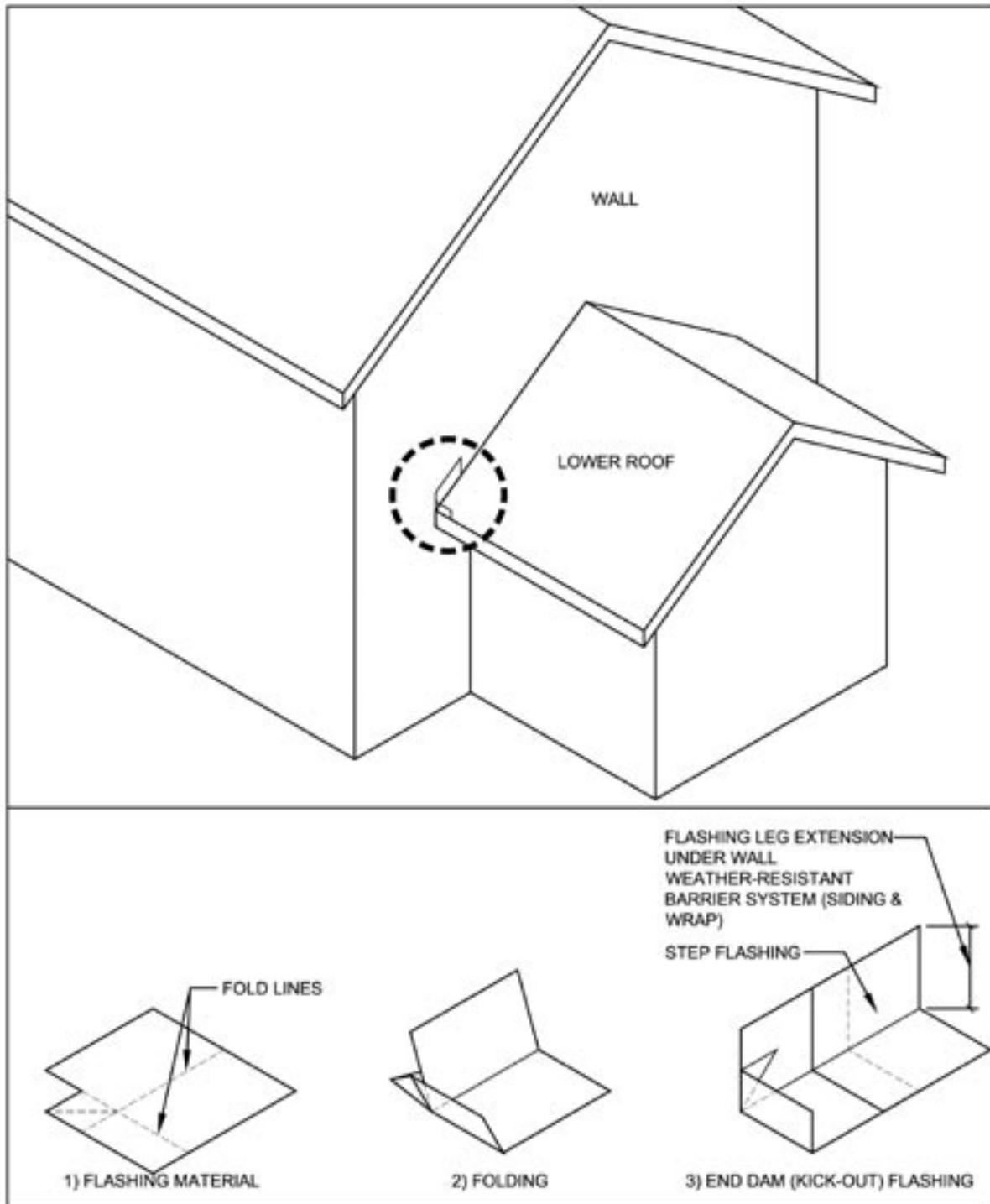

Figure 7 - End Dam (Kick-out) Flashing
(Eave Termination at Wall)

2.2.3 Roof Ventilation and Insulation

- do not simply depend on roofing cement or caulk. In addition, improper or lacking kick-out flashing (which may involve only a single roof flashing component) is associated with some of the more severe cases of localized moisture damage to walls. This flashing element is highlighted in Figure 7.

To ensure that the eave ice dam flashing extends 24" horizontally beyond the exterior wall, the slope of the roof should be accounted for. Table 2 offers nominal width requirements for the eave ice dam flashing based on different roof slopes and eave overhangs. Note that for many scenarios a single 36" roll of flashing may not be sufficient.

REFERENCES AND ADDITIONAL RESOURCES

Architectural Sheet Metal Manual, Sheet Metal and Air Conditioning Contractors National Association, Inc. 2003, www.smacna.org

Designing Roofs to Prevent Moisture Infiltration, Build a Better Home®, Form No. A535, APA The Engineered Wood Association, Tacoma WA, 2001, www.apawood.org

Durability by Design: A Guide for Residential Builders and Designers, U.S. Department of Housing and Urban Development, Washington DC, 2002, www.huduser.org

Energy & Environmental Building Association's *Builder Guides*. www.eeba.org/mail/builderguides.asp.org

Flashings Best Practice Guide: Building Technology. Canada Mortgage and Housing Corporation (CMHC), www.cmhc.ca

International Residential Code (IRC), International Code Council, Inc., Falls Church VA, 2003, www.iccsafe.org

NRCA Roofing and Waterproofing Manual, Fifth Edition. National Roofing Contractors Association, 2003, www.nrca.net

Parker, D., Sonne, J., Sherwin, J., "Comparative Evaluation of the Impact of Roofing Systems on Residential Cooling Energy Demands in Florida," Proceedings of ACEEE 2002 Summer Study, American Council for an Energy Efficient Economy, Washington, DC, August 2002.

2.2.3 Roof Ventilation and Insulation

OBJECTIVES: Roof system ventilation and insulation are important for a number of reasons:

- condensation control
- temperature control
- energy efficiency
- prevention of chronic ice dam formation

Ventilating attic areas is intended to prevent the accumulation of moisture vapor in the roof space and to dry low levels of condensation that may form on the underside of a roof deck. Ventilation is also intended to reduce the temperature of the roof deck during hot periods to improve shingle durability. Reducing attic temperature through ventilation and insulation also improves energy efficiency during hot periods. And in the case of ice dams, elevated attic and roof temperatures during the winter can cause snow on the roof to melt. Insulation and roof ventilation help to keep the roof's exterior surface cold and minimize the development of melt water and consequently ice dams.

PRECAUTIONS: Ventilating roofs in hot/humid conditions may add - rather than remove - moisture from attics and enclosed roof spaces. However, not ventilating roofs may void the asphalt composition roofing manufacturer's warranty and slightly decrease roofing life expectancy due to increased roof surface temperature. Other tile, concrete, or metal

2.2.3 Roof Ventilation and Insulation

roofing materials would not be similarly affected. Employing an unvented attic space can be done, but may require designing the attic/roof space as conditioned space – similar to that required when creating habitable space in the attic. The references section contains several sources with more information on unvented attic designs. Traditional attic ventilation remains a cost-effective, though imperfect solution, for moisture control. In colder climates, roof ventilation serves to remove humidity (or condensation) from the roof/attic space and helps to prevent the chronic formation of eave ice dams (see text box).

BEST PRACTICE:

Design Roof Ventilation Based on Climate and Insulation Amount

Attic spaces and roof cavities should be ventilated in accordance with minimum local building code requirements as represented in Table 3. Sample roof ventilation configurations are shown in Figure 8.

What Causes Ice Dams?

Ice dams are caused by warming of attics. And while attic ventilation and insulation contribute to the prevention of ice dams by keeping attics cold, they can be overpowered by other attic warming effects - such as air leakage from the house into the attic through ceiling bypasses or un-insulated ducts placed in the attic. If significant conditioned air escapes into the attic through bypasses, the attic ventilation will not be capable in preventing the warming of the roof decking and subsequent ice dams. ***Therefore sealing air leaks between the house and the vented attic is essential to making attic ventilation work.*** See Section 2.5.5 Controlling Air Leakage for information on preventing air leakage into attics. Air leakage from the interior into the attic also introduces moisture. If significant interior air leaks into an attic, attic ventilation may not be sufficient to prevent attic moisture and condensation problems.

Table 3 - Minimum Roof Ventilation Requirements

Applicability Requirements	Ventilation Amount ^a
Vertical separation of inlet and outlet vents is less than 3 feet	1:150
Vertical separation of inlet and outlet vents is at least 3 feet with balanced inlet and outlet vent areas ^b or a vapor retarder is installed on the warm side of the ceiling	1:300

Table Notes:

- a. Values are given as ratio of total net (unobstructed) open area of inlet plus outlet vents to total horizontal projected area of the ventilated space. Therefore, vent size must be increased to account for obstructed vent area due to louvers and screens (refer to vent manufacturer technical data).
- b. Inlet and outlet vent areas shall be considered balanced provided that at least 50 percent and not more than 80 percent of the required ventilating area is provided by ventilators located in the upper portion of the space to be ventilated.

2.2.3 Roof Ventilation and Insulation

Table 4 - Recommended Roof Ventilation Levels to Prevent Chronic Ice Dams
(for climates with ground snow load ≥ 30 psf and other areas prone to ice dams) ^{a,b}

R-value of Roof/attic Insulation ^c	Vertical Separation of Inlet (Eave/Cornice) and Outlet (Ridge or Gable) Vents			
	3 ft	6 ft	9 ft	12 ft
Vented Attic Roofs				
R 19	1:100	1:140	1:180	1:200
R 30	1:160	1:230	1:280	1:300
R 38	1:200	1:290	1:300	1:300
R 49	1:260	1:300	1:300	1:300
Vented Cathedral Roofs				
R 19	1:100	1:140	1:250	1:250
R 30	1:160	1:230	1:250	1:250
R 38	1:200	1:250	1:250	1:250
R 49	1:250	1:250	1:250	1:250
Minimum Vent Depth for Air Passage in Cathedral Roofs				
Roof Pitch	Vent Depth ^d			
3:12 to 5:12	2"			
> 5:12	1-1/2"			

Table Notes:

- a. This table applies to roofs with a pitch of at least 3:12, an R-value of at least R 19, and a distance between inlets and outlets of no more than 40 feet.
- b. Values are given as a minimum ratio of total net open (unobstructed) area of inlet and outlet vents to total horizontal projected area of the ventilated space. Inlet and outlet areas shall be balanced to the maximum extent practicable. For example on a simple gable roof, one-half of the calculated vent area shall be at the ridge and one-fourth at each of the two eaves.
- c. For the purpose of determining ventilation requirements, roof/attic insulation shall meet or exceed insulation amounts required by the local building code.
- d. Minimum vent depth shall be maintained for entire ventilation air flow path from eaves to ridge or gable vents.

For enhanced protection against the formation of ice dams, Table 4 provides recommended insulation levels and vent area ratios as a function of the venting layout. These recommendations should be employed in areas with a ground snow load greater than 30 pounds per square foot (psf) and strongly considered in other areas where ice dams are a concern.

The ventilation recommendations in Table 4 should be used *in addition to* eave ice dam flashing to create multiple lines of defense (refer to Section 2.2.2). Also, the arrangement of vent areas must balance high (outlet) and low (inlet) vent openings.

2.2.3 Roof Ventilation and Insulation

ILLUSTRATED BEST PRACTICE:

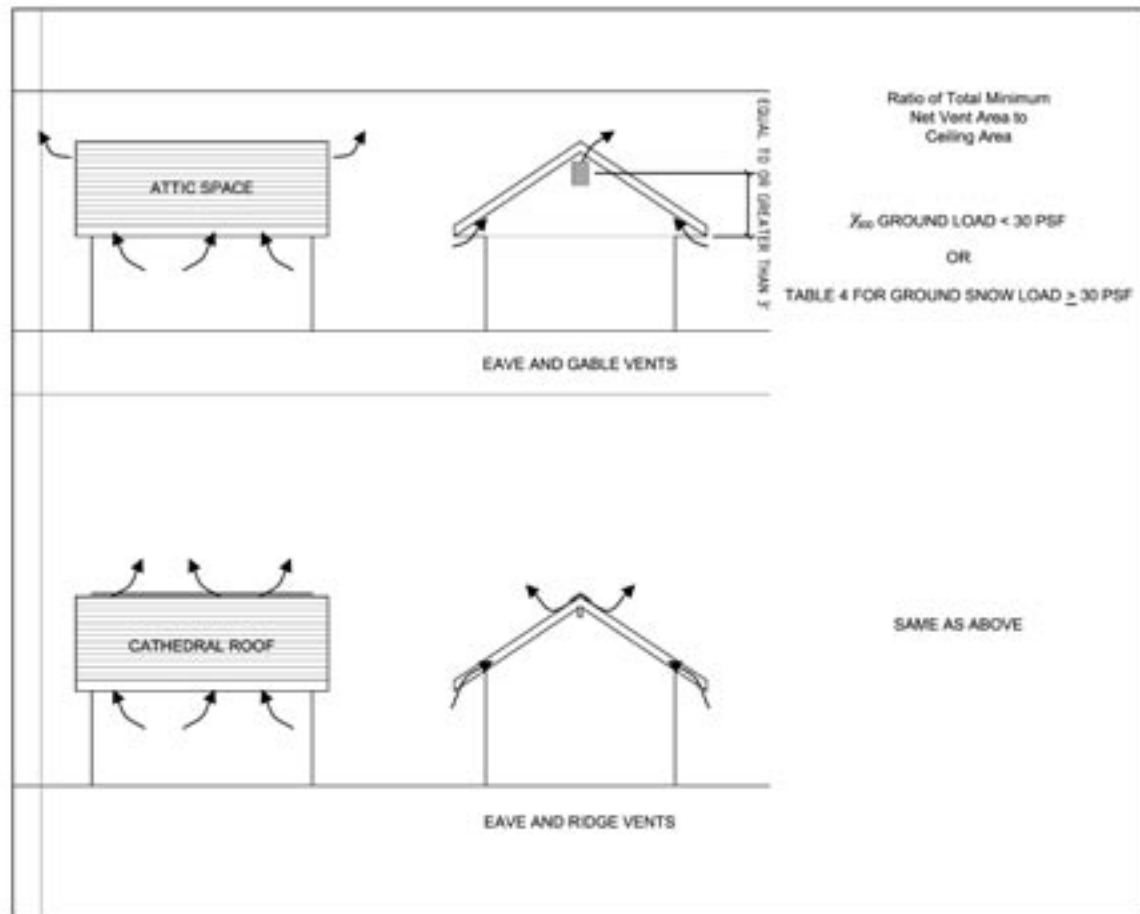

Figure 8 - Roof Ventilation Configurations

REFERENCES AND ADDITIONAL RESOURCES:

Crandell, J.H., "Ice Dams, Traditional and Improved Practices for Roof Ventilation and Prevention of Ice Dams," *Disaster Safety Review*. Institute for Business and Home Safety, Tampa FL, 2004

Energy & Environmental Building Association's Builder Guides, www.eeba.org/mail/builderguides.asp.org

International Residential Code (IRC), International Code Council, Inc., Falls Church VA, 2003, www.iccsafe.org

NRCA Roofing and Waterproofing Manual, Fifth Edition. National Roofing Contractors Association, 2003, www.nrca.net

Parker, D., Sonne, J., Sherwin, J., "Comparative Evaluation of the Impact of Roofing Systems on Residential Cooling Energy Demand in Florida," *Proceedings of ACEEE 2002 Summer Study, American Council for an Energy Efficient Economy*, Washington DC, August 2002

2.2.4 Roof Overhangs and Projections

Table 5 - Recommended Minimum Roof Overhang Width ^a

Decay Hazard Index	Eave Overhang (Inches)	Rake Overhang (Inches)
Less than 35	N/A	N/A
35 to 70	12	12
More than 70	24 or more	12 or more

Table Note:

a. Table based on typical 2-story home with vinyl or similarly durable siding and eave gutters.

2.2.4 Roof Overhangs and Projections

OBJECTIVES: Roof overhangs and projections such as porch roofs or overhanging floors provide a primary means to deflect rain water away from building walls. Thus, the potential for water penetration through siding, windows, and doors is minimized. Because the protection of roof overhangs increases

with increasing overhang width, larger overhangs than those recommended in this section may be important in the consideration of wall weather-resistant barrier design (refer to Section 2.3.1).

PRECAUTIONS: Roof overhangs offer limited benefit during periods of severe wind-driven rain conditions (e.g., thunderstorm fronts and tropical storms) and in arid regions

ILLUSTRATED BEST PRACTICE:

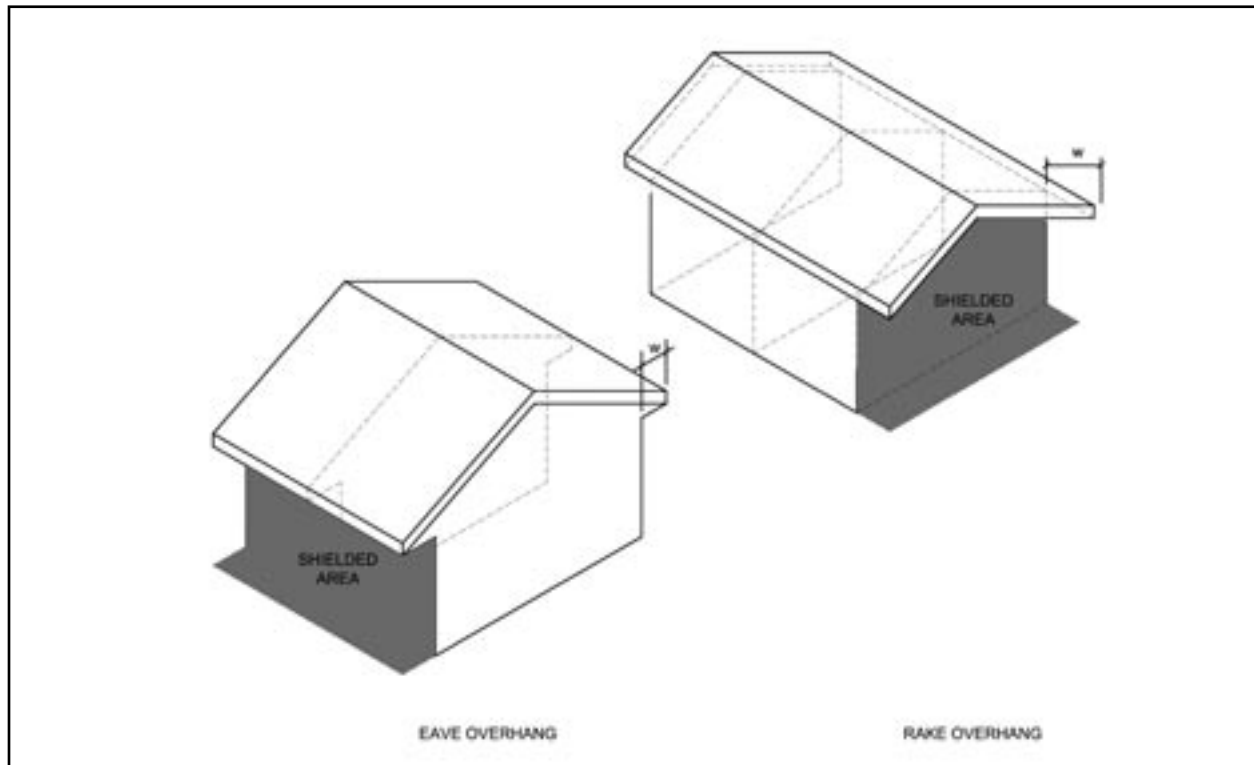

Figure 9 - Roof Overhangs

2.2.4 Roof Overhangs and Projections

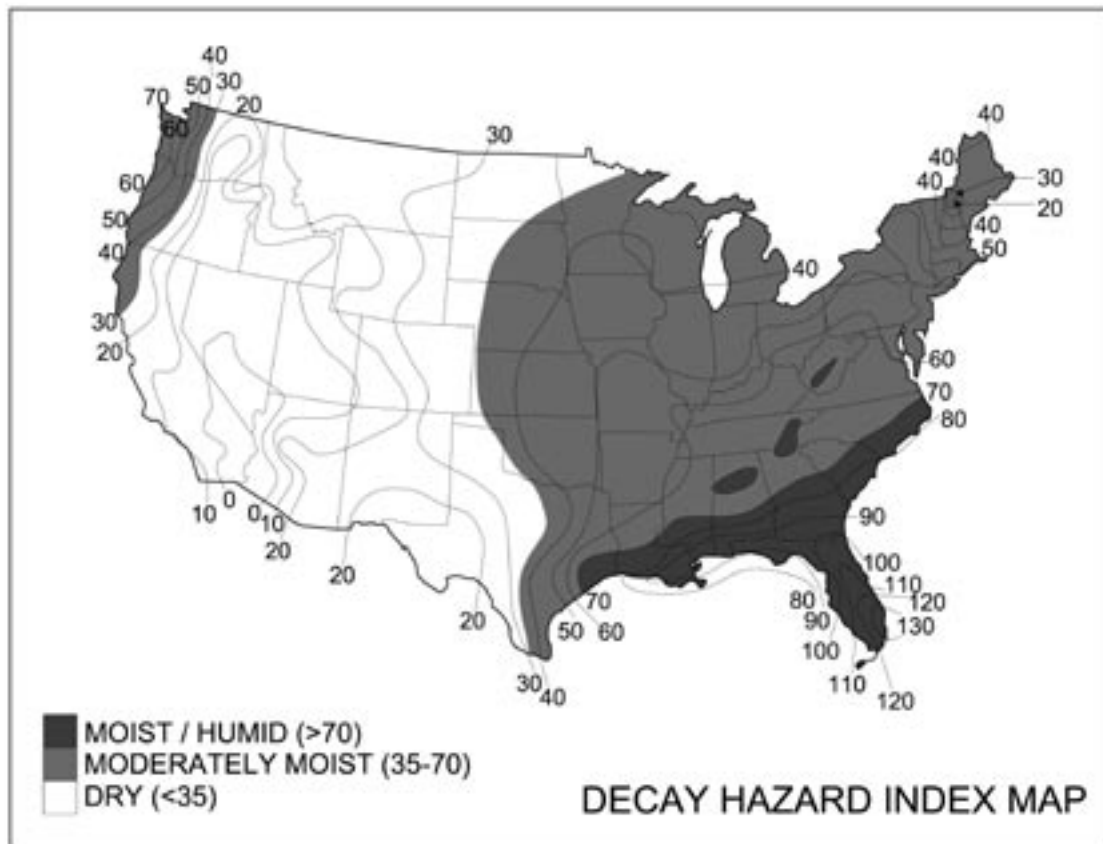

Figure 10 - Decay Hazard Index Map

(Based on *A Climate Index for Estimating Potential for Decay in Wood Structures Above Ground*, Scheffer, 1971)

where rain is not a major concern. In severe wind-driven rain climates, a good performing weather-resistant barrier for walls is at least as important as providing roof overhangs (refer to Section 2.3.1). In high wind areas, overhangs add wind uplift load to the roof and may require stronger roof-wall connections.

BEST PRACTICE:

Design Roof Overhangs based on Climate

Recommended minimum roof overhang widths for one- and two-story wood-frame buildings are shown in Table 5 and Figure 9.

For taller buildings, larger roof overhangs should be considered. Alternatively, porch roofs or floor overhangs can be used to protect lower story walls in accordance with

Table 5. A decay hazard index map is provided in Figure 10 to assist in using Table 5. It should be noted that model U.S. building codes do not regulate a minimum roof overhang width.

REFERENCES AND ADDITIONAL RESOURCES:

Durability by Design: A Guide for Residential Builders and Designers, U.S. Department of Housing and Urban Development, Washington DC, May 2002, www.huduser.org

Verrall, A.F., and Amburgey, T.L. 1978. *Prevention and Control of Decay in Homes*. Prepared by Southern Forest Experiment Station, Gulfport, MS for U.S. Department of Housing and Urban Development, Washington DC

2.2.5 Roof Drainage, Gutters, and Downspouts

OBJECTIVES: While roof overhangs and porch roofs protect building walls from impinging rain, gutters serve to protect building walls and foundations from roof water run-off. Roof gutters, downspouts, and leaders form the initial components of a drainage system for the building and site. This best practice provides guidance for the proper design of gutters and downspouts for water shedding (steep slope) roof systems.

PRECAUTIONS: Common problems with guttering are associated with installation and maintenance. Be sure that properly sized materials are used, guttering is appropriately sloped toward adequately sized downspouts, and discharge is directed away from the building perimeter. Discharging water at inside building corners should be avoided. Some local storm water requirements may require special infiltration or filtration treatments of roof run-off. However, these practices should never be employed near the building foundation perimeter.

BEST PRACTICE:

Design a Properly Sized Roof Drainage System

Only two steps are required to properly design a steep-slope roof drainage system using standard guttering products.

STEP 1: DETERMINE DESIGN RAINFALL INTENSITY

The design rainfall intensity for roof drainage design is sometimes based on a 10-year return period and 5-minute duration (see Figure 11). However, other design return periods and durations may be used effectively. Adjustment factors for other

acceptable design conditions are given below. A standardized design criterion in U.S. model building codes does not exist, so practical experience and judgment are important.

STEP 2: DETERMINE ROOF DRAINAGE SYSTEM SPACING & LAYOUT

Based on a selected gutter size and type as well as the design rainfall intensity from Step 1, determine the maximum plan (horizontal) area of the roof that the gutter can adequately serve from Table 6. Based on this area and the roof geometry, downspout spacing and locations can be determined as shown in the example below. If suggested downspout sizes are used, gutter size will generally control the spacing of downspouts. Downspouts with a dimension less than 2 inches should be avoided. It is also generally recommended that downspouts should serve no more than 50 feet of gutter length. A commonly used gutter is the 5" K-style gutter with 2"x3" rectangular downspouts.

Collected roof rainwater (gutters) delivered to grade (downspouts) must then be moved away from the foundation onto properly graded soil (leaders). This third component is just as important as the first two, and should receive equal emphasis. Leaders should direct the downspout discharge a minimum of 2 feet away from the building perimeter. This can be done using splashblocks or an underground drainage pipe (e.g., corrugated polyethylene or smooth PVC piping) discharging to a safe conveyance point. In particularly poor soil conditions such as expansive clays or collapsible soil (severely weakened with increased moisture), downspout discharge distance from the foundation should be increased.

For the house shown in Figure 12, the following example is provided to illustrate this best practice:

2.2.5 Roof Drainage, Gutters, and Downspouts

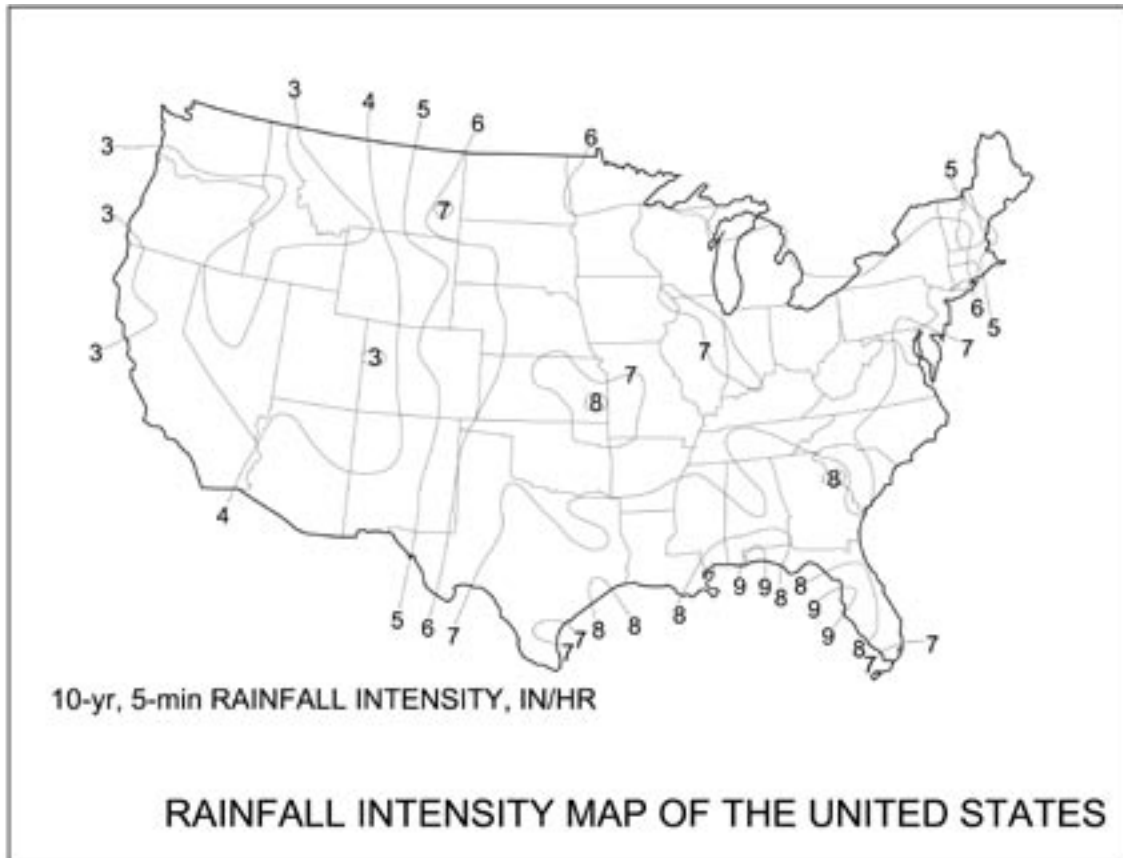

Figure 11 - Rainfall Intensity Map of the United States

To convert mapped rainfall intensity value to:	Multiply mapped value by:
5 yr, 5-min	0.8
10 yr, 10-min	0.85
25 yr, 10-min	0.9
25-yr, 5-min	1.15

STEP 1: From Figure 11, a design rainfall intensity of 7 in/hr is determined for the site.

STEP 2: A 5" K-style gutter is selected from Table 6 with a maximum allowable roof tributary plan area of 600 ft². Because the roof slope is 6:12, the allowable tributary roof area is 0.85 x 600 ft² = 510 ft². The actual roof area for the side shown is 14'x34' + 14'x12' = 644 ft². The number of downspouts required is 644 ft² / 510 ft² = 1.3. The number of downspouts should always be rounded up, so two downspouts should be used, one at each end of the L-shaped gutter layout. The downspout size may be 2x3 or 3x4 as suggested in Table 6.

REFERENCES AND ADDITIONAL RESOURCES

Architecture Design Handbook, Copper Development Association, www.copper.org

Durability by Design: A Guide for Residential Builders and Designers, U.S. Department of Housing and Urban Development, Washington DC, May 2002, www.huduser.org

"Surface Water", Clause E1, Approved Document for New Zealand Building Code, Building Industry Authority, Wellington NZ, 2001

2.2.5 Roof Drainage, Gutters, and Downspouts

Table 6 - Maximum Allowable Tributary Roof Plan Area
(Roof Slope \leq 5:12)

Gutter Size and Type	Design Rainfall Intensity (in/hr)								Suggested Downspout
	3	4	5	6	7	8	9	10	
5 1/2"-round	775	581	465	387	332	291	258	232	3"
6 1/2"-round	1272	954	763	636	545	477	424	382	3" or 4"
4" K-style	763	572	458	382	327	286	254	229	2x3
5" K-style	1399	1050	840	700	600	525	466	420	2x3 or 3x4
6" K-style	2279	1709	1367	1139	977	854	760	684	3x4

Table Notes:

- The tributary area served by gutter is defined by L x W. L is the length of the gutter to both sides of a downspout measured to termination of the gutter or to the high-point (drainage divide) between downspouts. W is the plan (horizontal) distance from the eave to the ridge of the roof area served.
- The values in the table assume gutters with a minimum slope to prevent ponding and reverse flow. For gutters sloped at 1/16 inch per foot or greater, the table values may be multiplied by 1.1.
- Allowable drainage areas in Table 2.2.6 are intended for roof slopes \leq 5:12. For steeper roof pitches, multiply the tabulated areas by 0.85.

ILLUSTRATED BEST PRACTICE:

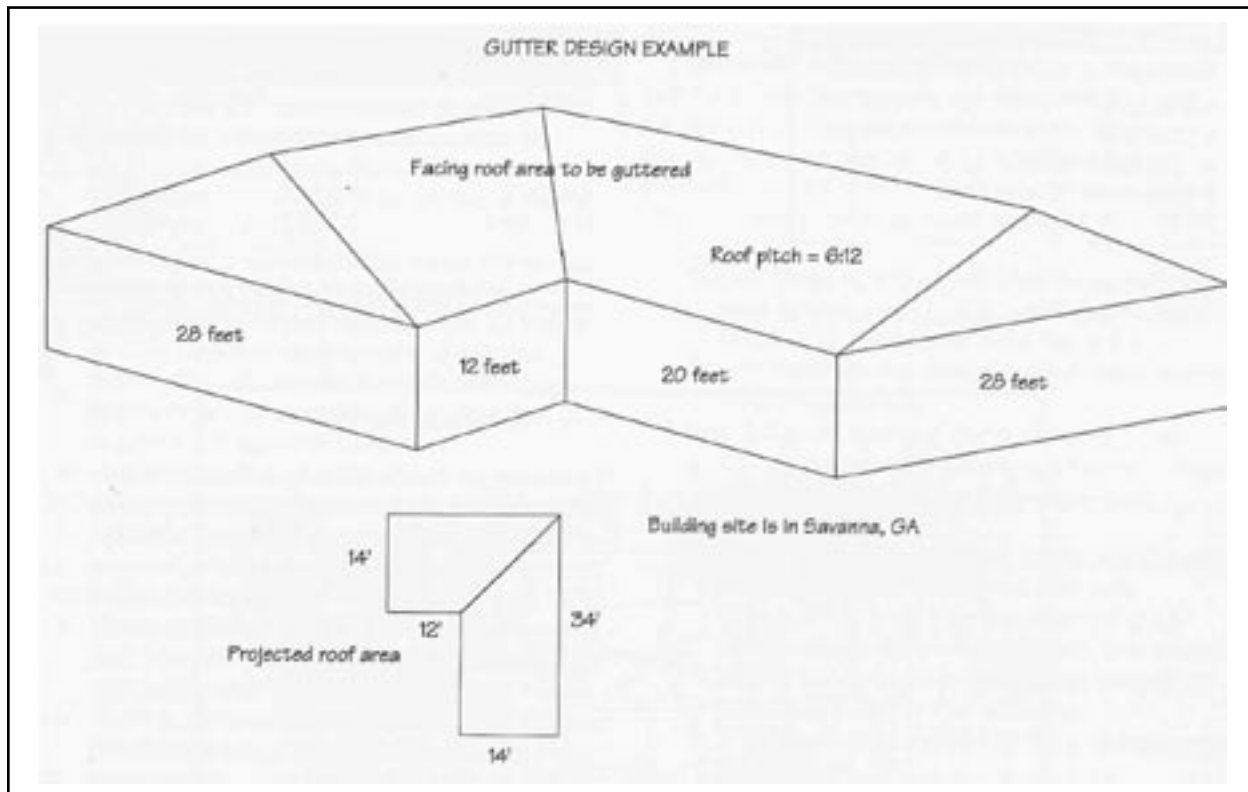

Figure 12 - Roof Drainage Design Example

2.3 Best Practices for Moisture-Resistant Wall Systems

2.3.1 Weather-Resistant Exterior Wall Envelope

OBJECTIVES: This best practice provides recommendations for selection of the weather-resistant wall envelope (e.g., siding, water barrier, etc). Current U.S. building codes don't distinguish the inherent performance differences between various weather-resistant envelope (WRE) systems. In addition, selection of a siding system generally focuses on attributes such as appearance, cost, and durability. The WRE selection procedure in this section considers the ability of different types of cladding systems to protect a building from rainwater penetration and accumulation in walls. Thus, trade-offs between moisture performance and other architectural considerations are more readily identified and resolved. This best practice is intended to enhance or help fulfill the basic objective for the weather-resistant wall envelope as found in the 2003 International Residential Code:

R703.1 General. Exterior walls shall provide the building with a weather-resistant exterior wall envelope. The exterior wall envelope shall include flashing as described in Section R703.8. The exterior wall envelope shall be designed and constructed in such a manner as to prevent the accumulation of water within the wall assembly by providing a water-resistant barrier behind the exterior veneer as required by Section R703.2.

PRECAUTIONS: Selection of even the most weather-resistant wall envelope system does not diminish the need for proper installation, particularly in regard to flashing details at penetrations. In addition, use of roof overhangs provides performance benefits for all cladding

systems by reducing the moisture load experienced over time and by allowing greater opportunities for walls to dry in the event of periodic wetting due to wind-driven rain. The life-expectancy of various siding materials may vary widely from 10 to as much as 100 years or more depending on type of material, climate exposure, maintenance, and other factors.

It should be noted that recent building codes, such as the 2003 International Residential Code (IRC), have not required secondary weather barriers (e.g., asphalt-impregnated felt paper or building wrap) under many types of horizontal lap siding. But requirements for secondary weather barriers are becoming more broadly required based on the 2004 Supplement to the IRC. This trend generally agrees with this guide's recommendations for the use of secondary weather barriers, particularly in areas with significant wind-driven rainfall.

BEST PRACTICE:

Design for a Weather-Resistant Envelope System

A drained cavity WRE system will provide fair to good protection in nearly all climates and building exposures, and should be considered as a broadly applicable wall design approach for moisture protection. In more severe cases like climates with severe wind-driven rain or openly exposed buildings with no overhangs, and for wall designs involving different types of materials (e.g., conventional stucco), alternative WRE systems can be selected based on climate and building exposure. A 3-step design process which accounts for these factors follows in this section.

The drained cavity system and other WRE approaches are illustrated in Figure 13 and described below.

2.3.1 Weather-Resistant Exterior Wall Envelope

ILLUSTRATED BEST PRACTICE:

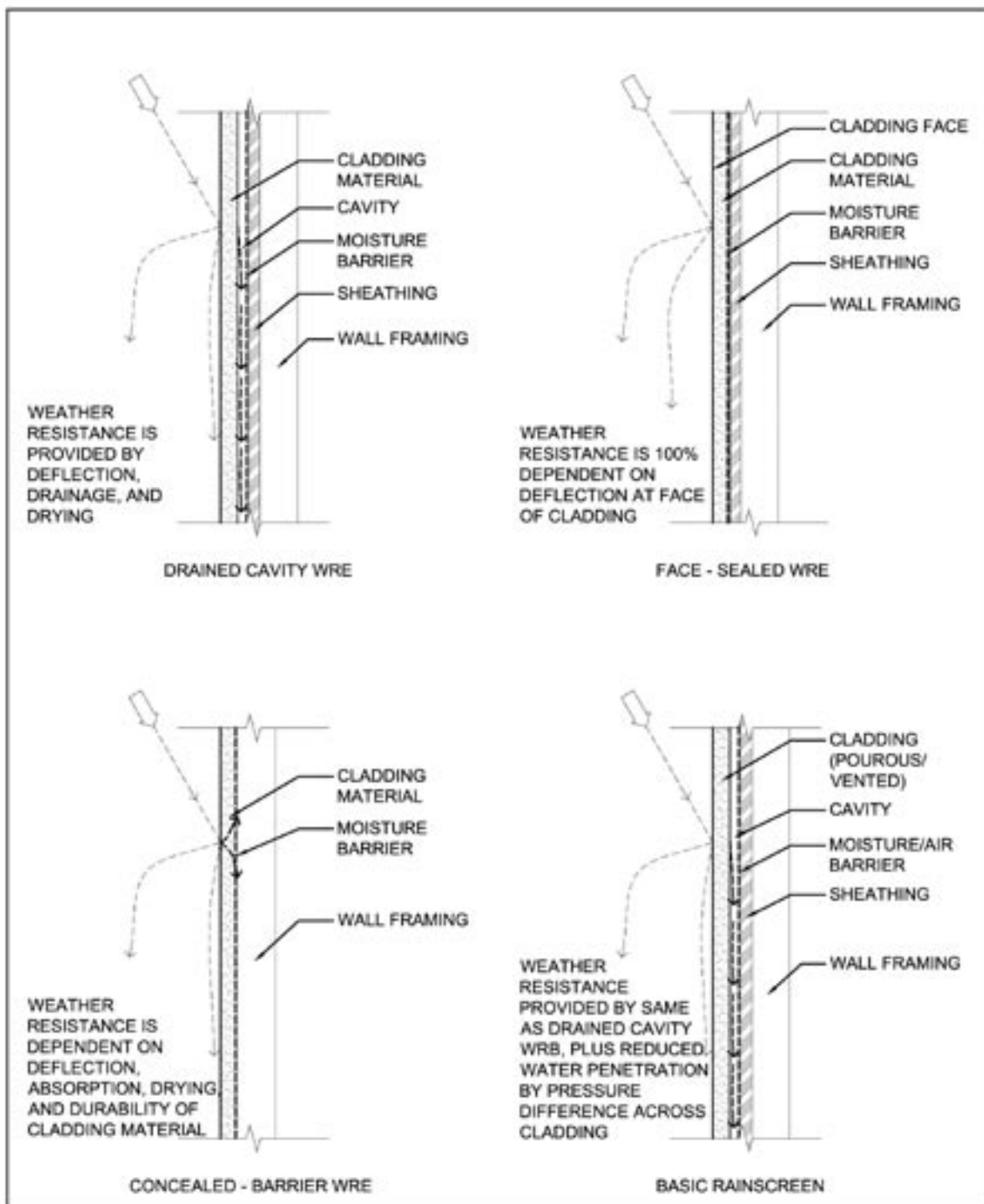

Figure 13 - Illustration of WRE Systems

Drained Cavity – A drained cavity WRE relies on deflection, drainage, and drying to protect the wall from moisture damage. There are many possible variations of this type of WRE. In general, a cavity exists to separate the cladding material from the surface of a moisture barrier placed on the structural wall behind the cladding. The depth of the cavity, however, may vary. For example, vinyl siding may be placed directly on the moisture barrier (e.g. building wrap, 15# tarred felt) and still provide a cavity only restricted at points of contact (e.g., nail flanges). A minimum cavity depth of 3/8" to 1/2" is sometimes recommended by use of vertical furring strips placed over the water barrier (drainage plane). Furring and flashing details around window and door openings must also be carefully planned and executed. Drained cavities increase the life of exterior finishes on wood surfaces and promote drying of wall assemblies after wetting episodes. For brick veneer, a larger 1" cavity depth is recommended to allow space for brick placement and mortar excesses.

Face-sealed – This type of WRE relies exclusively on the ability of the outer surface of the wall and joints around penetrations to deflect water and prevent it from penetrating the wall surface. If a defect in the wall surface or joint detailing (e.g., caulk) exists or occurs over time, then water will penetrate and potentially accumulate in the wall - causing damage to any moisture-sensitive materials within the assembly. One example of this type of system is known as conventional or barrier EIFS (exterior insulation finish system). However, current model building codes only allow the use of a new type of drainable EIFS (i.e., drained cavity) on residential construction.

Concealed Barrier – This type of WRE relies on porous cladding material adhered to or placed directly on an internal (concealed) water barrier or drainage plane. A common example is conventional stucco applied on a layer of tarred felt paper attached to a wood-frame

Specification and Installation of Drainage Planes (Moisture Barriers)

The secondary drainage plane (moisture barrier) is a key feature of any of the WRE systems that rely on drainage behind the exterior siding to improve moisture-resistant performance. Materials commonly used for this purpose include 15# tarred felt, various types of building wraps, and some water-resistant insulating sheathing products. It should be noted, however, that building wraps have varied levels of water resistance (as well as moisture vapor permeability). The primary role of these materials is as a secondary drainage plane. In general, non-perforated building wraps tend to exhibit better water resistance than other types that may be perforated to allow for vapor permeability. In humid climates, moderate vapor permeability along with adequate water resistance may be preferable. Limited testing demonstrates that material candidates meeting these criteria include Tyvek, R-Wrap, and 15# felt. Because the secondary drainage plane is intended to drain moisture that penetrates siding and joints, its installation must be properly coordinated with flashing and other WRE components (refer to Sections 2.3.2 and 2.3.3). In addition, all joints must be appropriately lapped (e.g., upper layer over top of lower layer). These features are hidden underneath the siding and must be properly installed prior to or in coordination with siding application. If water leaks behind the secondary drainage plane, it may cause more damage than if no drainage plain were present due to slower drying. Additional requirements when using building wraps as an exterior air barrier are discussed in Section 2.5.5.

Conversion of Existing WRE Systems

It is possible to adapt a drained cavity approach to many traditional concealed barrier or face-sealed claddings, such as conventional Portland cement stucco and EIFS. Drainable EIFS products (a drained cavity WRE) in lieu of barrier EIFS products (a face-sealed WRE) are the only types permitted for residential use under U.S. model building codes.

Details to convert conventional Portland cement stucco (concealed barrier) to a drained cavity system have been developed for use in British Columbia (Canada), where a high frequency of water intrusion problems has been experienced. Consult References and Additional Resources for more detailed information.

wall. This WRE system also relies primarily on deflection of rainwater (like the face-sealed system) but also has limited capability to absorb moisture to later dry and to drain moisture through weeps (e.g., weep screed) at the base of the wall. However, there is no open drainage pathway to allow water to freely drain from the concealed moisture barrier.

Rainscreen – A rainscreen can be considered as an incremental improvement of the drained cavity approach. This type of WRE is uncommon in the U.S. but has been used to some extent in Canada to address severe climate conditions. By the addition of some details to help reduce air-pressure differential across the cladding system during wind-driven rain events, water penetration into the drainage cavity is further limited. At a minimum, this approach involves use of an air barrier behind the cladding to resist wind pressures. Thus, wind pressure across the siding (which is vented and not air-tight) is reduced and is less likely to result in water

being driven through the siding due to pressure differentials across the siding. Also, the cavity between the cladding and water/air barrier must be compartmentalized by use of air-tight blocking or furring at corners of the building as a minimum practice. This feature prevents pressure differences on different surfaces of the building from “communicating” through a continuous cavity behind the cladding, which can cause unintended pressure differences across the cladding that drive rain water through the cladding into the drainage cavity. Because many of the required components of a basic rainscreen system are already present in a simple drained cavity wall system, drained cavity systems are generally considered a more practical alternative for typical applications.

Drained cavity WRE systems incorporate a wide range of cladding systems and may be considered as a viable option for non-severe climates and building exposures. The design process below can be used to assess alternative WRE systems for severe climate or site conditions or when alternative systems are desired.

STEP 1: ASSESS SITE CLIMATE CONDITION

Climatic conditions are categorized on the basis of the potential for wetting of walls, especially wetting from wind-driven rain. The exposure categories are:

- **Severe** – severe climate conditions are conditions that result in frequent wetting due to wind-driven rain, such as coastal climates and areas prone to frequent thunderstorm events.
- **Moderate** – moderate climate conditions are those which are periodically exposed to wind-driven rain.
- **Low** – a low climate condition is associated with relatively dry climates with little rainfall or wind-driven rain.

2.3.1 Weather-Resistant Exterior Wall Envelope

The above classifications are intentionally subjective, as there are no clearly defined criteria in the U.S for assessing wind-driven rain and its effects on building wall systems. However, wind-driven rain climate data - as well as other related climate indices - may help guide the classification of a local climate based on the categories above. Climate maps for this purpose are provided in Figures 14 and 15. The reader should consult the referenced sources of the maps for additional information. In addition, the Decay Hazard Index map of Figure 10 may also provide some guidance.

STEP 2: ASSESS BUILDING EXPOSURE

The terrain surrounding a building impacts its exposure to wind driven rain. The ratio of roof overhang width to the height of the protected wall below also alters the exposure of a building to weather and wind-driven rain. Long roof overhangs relative to wall height effectively reduce the exposure. Similarly, increased shielding of the site against wind tends to reduce the effects of climate.

Table 7 may be used to determine a building's exposure level, based on the climate condition

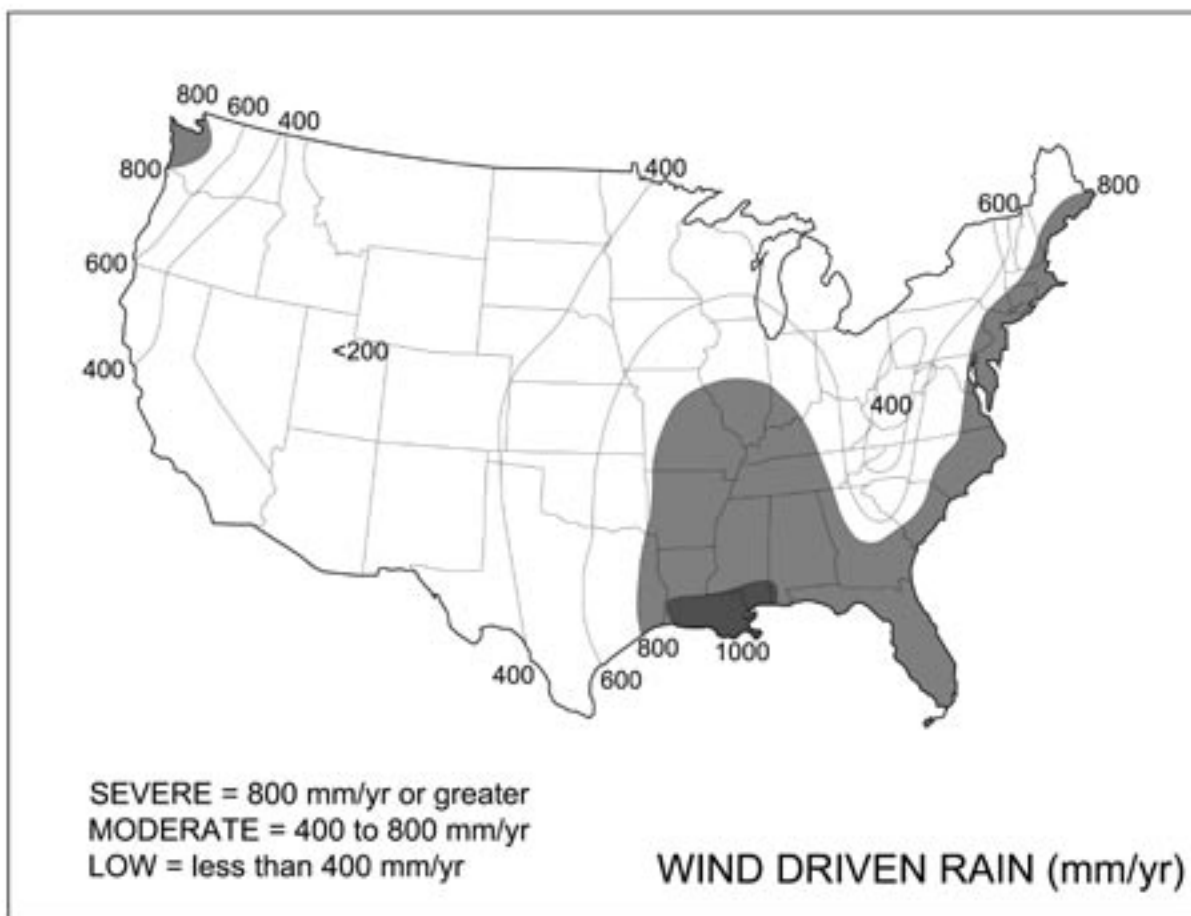

Figure 14 - Wind-driven Rain Map of the United States

(Source: Underwood, University of Georgia, 1999)

2.3.1 Weather-Resistant Exterior Wall Envelope

determined in Step 1, the roof overhang ratio, and the wind exposure. The exposure level then leads to a reasonable weather-resistant envelope approach in Step 3. The exposure levels in Table 7 can also be used on a smaller scale to get a sense of the exposure for particular faces of a building or even for specific envelope elements like a window. Understanding the exposure in this manner can guide decisions on flashing details, potential use of greater overhangs, etc.

The wind exposure conditions in Table 7 are explained as follows:

- *No Shielding (Open)* – site receives no or little protection from surrounding buildings and natural obstructions to wind flow (e.g., grassy field or waterfront exposure).
- *Partial Shielding* – site receives protection from typical suburban development including surroundings of homes and natural or man-made landscaping (e.g., interspersed trees of similar or greater height than buildings).
- *Full Shielding* – site receives significant protection from surrounding dense

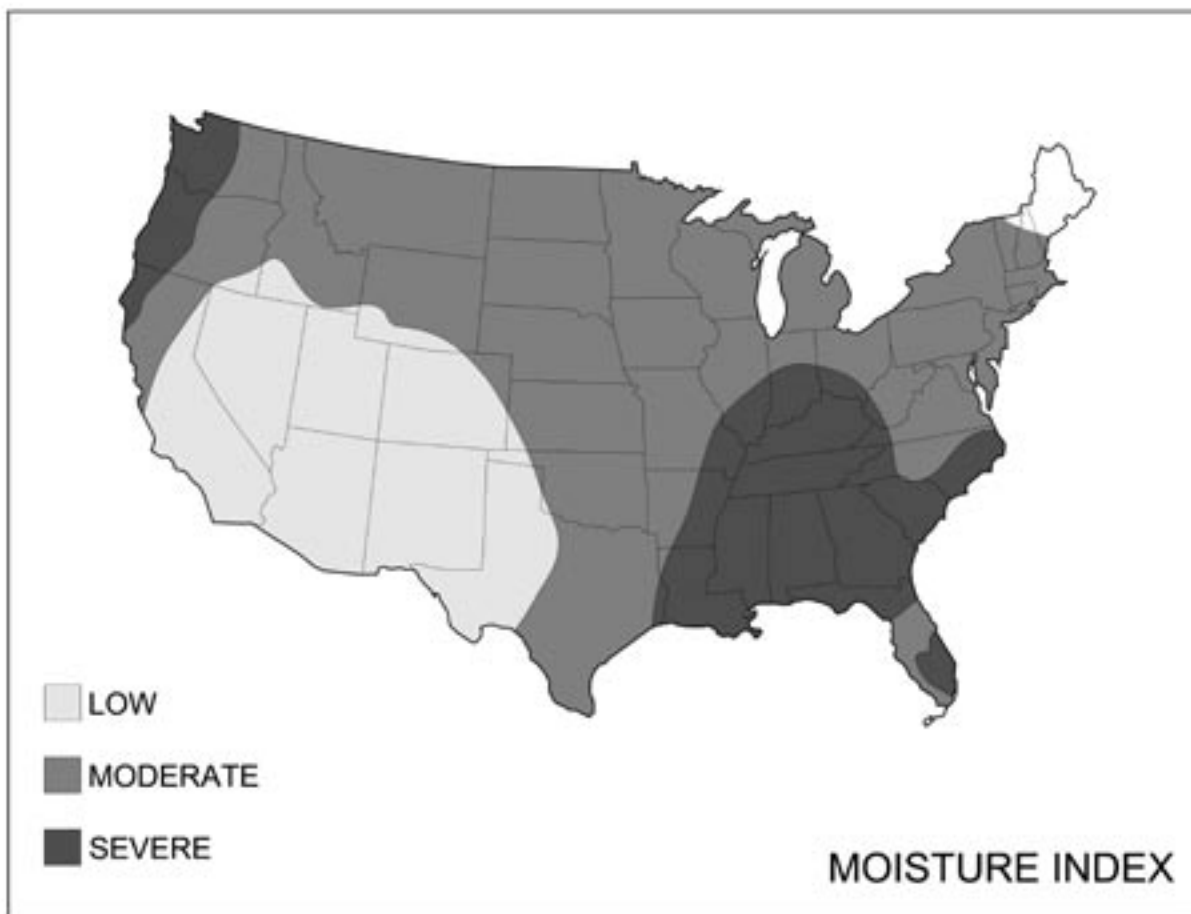

Figure 15 - Moisture Index for North America
(Based on *Keeping Walls Dry*, Kerr D., CMHC, 2004)

2.3.1 Weather-Resistant Exterior Wall Envelope

Table 7 - Building Exposure Levels
(H-high; M-moderate; L-low; N-negligible exposure)

Wind Exposure	Overhang Ratio ^a (w/h)	Climate Severity ^b (from Step 1)		
		Severe	Moderate	Low
No Shielding (Open)	0	H	H	M
	0.1	H	M	L
	0.2	M	L	L
	0.3	M	L	N
	0.4	L	L	N
	≥0.5	L	N	N
Partial Shielding (Typical Suburban)	0	H	H	M
	0.1	H	M	L
	0.2	M	L	N
	0.3	L	N	N
	0.4	L	N	N
	≥0.5	N	N	N
Full Shielding	0	H	H	M
	0.1	M	M	L
	0.2	L	L	N
	0.3	L	N	N
	0.4	N	N	N
	≥0.5	N	N	N

Table Notes:

- Overhang ratio should account for both roof overhangs and overhangs from cantilevered floors. For a given wall, use the worst case overhang ratio (w/h) where 'w' is the overhang width and 'h' is the height of wall below the overhang.
- For buildings located near the top of topographic features such as ridges, bluffs, and escarpments, the building exposure level should be increased by one level.

development (e.g., more than 4 homes/acre) and/or closely spaced trees (e.g., generally more than 15 to 20 large trees/acre) extending for a horizontal distance of at least 10 building heights from the building.

STEP 3: SELECT WEATHER-RESISTANT ENVELOPE APPROACH

Based on the building exposure level determined in Step 2, a WRE approach may be selected based on relative performance

2.3.1 Weather-Resistant Exterior Wall Envelope

Table 8 - Relative Performance of WRE Approaches

Exposure Level (from Table 7)	Face-sealed	Concealed Barrier	Drained Cavity	Basic Rainscreen
High (H)	Poor	Poor	Fair	Good
Moderate (M)	Poor	Fair	Good	Good
Low (L)	Fair	Good	Good	Good
Negligible (N)	Good	Good	Good	Good

Table Note:
a. See discussion below on “mass wall” systems used as a weather-resistant barrier.

expectations. Alternatively, other factors may be reconsidered in the building and site design to improve protection from rain, like the use of larger overhangs to protect walls.

durability of cladding and other wall components, or the reliability of expected maintenance. Therefore, the ratings may be subject to adjustment by experience.

The approximate ratings used in Table 8 to describe relative performance are explained as follows:

- *Good* – the WRE system is likely to meet or exceed acceptable performance expectations and has a low risk of failure during the likely service life with a reasonable level of installation quality and maintenance.
- *Fair* – the WRE system is considered adequate, but may require careful attention to detailing, installation quality, and maintenance. The wall has a tolerable risk of failure during the likely service life.
- *Poor* – the WRE system has a relatively high risk of not meeting acceptable performance expectations.

These ratings don't consider numerous factors including the variation in constructability of various systems, the

Solid or mass walls, such as masonry and concrete wall systems without a separate exterior cladding, are not addressed in Table 8. These walls rely on deflection of rain as well as the ability to absorb moisture in a sufficiently thick and durable wall system. However, even these “mass” walls can become overwhelmed with moisture intake during extreme wind-driven rain episodes (e.g., hurricanes and tropical storms). Water-repellent surface treatments or coatings like latex paint may be applied to these walls to improve rain deflection and minimize absorption of moisture; however, such coatings should be semi-permeable to allow for drying towards the outside. Various water-repellant treatments are available for concrete and masonry, but they vary in cost, performance, and effective service life. Limited research indicates that polysiloxane-blended water repellents may provide the best water repellency and durability.

REFERENCES AND ADDITIONAL RESOURCES:

ASTM E1825-96 (2003) *Standard Guide for Evaluation of Exterior Building Wall Materials, Products, and Systems*, American Society for Testing and Materials, www.astm.org

ASTM E241-00 *Standard Guide for Limiting Water-Induced Damage to Buildings*, American Society for Testing and Materials, www.astm.org

Avoiding Moisture Penetration in Walls, Build a Better Home®, Form No. A530, APA The Engineered Wood Association, Tacoma WA, 2001, www.apawood.org

Best Practice Guide: Wood Frame Envelopes in the Coastal Climate of British Columbia, CMHC, April 9, 1997 (THIRD DRAFT), www.cmhc-schl.gc.ca

Crandell, J.H., *Exterior Insulation Finish Systems (EIFS): Lessons Learned, Advancements, and Challenges*, Insights, Institute for Business and Home Safety, Tampa FL, 2003, www.ibhs.org

Durability by Design: A Guide for Residential Builders and Designers, U.S. Department of Housing and Urban Development, Washington DC, 2002, www.huduser.org

Fisette, Paul. *Housewraps, Felt Paper and Weather Penetration Barriers*, Building Materials and Wood Technology, University of Massachusetts, 2001, www.umass.edu/bmatwt/publications/articles/housewraps_feltpaper_weather_penetration_barriers.html

International Residential Code (IRC), International Code Council, Inc., Falls Church VA, 2003, www.iccsafe.org

Introduction to External Moisture, Acceptable Solution E2/AS1, Building Industry Authority, New Zealand, 2004, www.building.dbh.govt.nz/e/publish/index.shtml

Kerr, D., *Keeping Walls Dry*, Canadian Mortgage and Housing Corporation, November 2004, www.cmhc-schl.gc.ca

Lstiburek, J.W., *Water Management Guide*, Energy & Environmental Building Association, Minneapolis MN, 2004, www.eeba.org

Performance Evaluation of Water Repellents for Above-Grade Masonry, Research Highlights, Technical Series 00-118, Canada Mortgage and Housing Corporation, Ottawa Canada, www.cmhc-schl.gc.ca/Research

Underwood, S.J., *A Multi-scale Climatology of Wind-driven Rain for the Contiguous United States 1971-1995*, PhD Dissertation, University of Georgia, Athens GA, 1999

Weather-Resistive Barriers, How to Select and Install Housewrap and Other Types of Weather-resistive Barriers, Technology Fact Sheet (October 2000), U.S. Department of Energy, Energy Efficiency and Renewable Energy Clearinghouse, www.eren.doe.gov

Woodframe Envelopes: Best Practice Guide, Canadian Mortgage Housing Corporation, 2001, www.cmhc-schl.gc.ca

2.3.2 Window & Door Components

OBJECTIVES: The three major window and door frame types used in conventional residential construction are wood, vinyl, and aluminum. Windows and doors can be key contributors to water penetration in walls, from either flashing failures around these components or characteristics of the components themselves. This section addresses the features of window and door components which may help reduce leakage and related moisture problems. Without careful evaluation of window and door components, it should be assumed that they will leak some amount of water into the wall cavity.

PRECAUTIONS: Simply relying on window and door products that are labeled according to standard test methods does not necessarily

guarantee that water leakage through frames into walls will not occur. Frames that rely on seals or sealants at internal or exposed joints will eventually leak water as these joints fail over time. The life expectancy of window and door units may vary widely from 10 to 50+ years depending on unit type and materials, exposure, maintenance, types of seals and sealants used at joints, and other factors. Frames that rely on “welding” of joints rather than sealants will generally provide a longer moisture-resistant service life.

BEST PRACTICES:

Follow the Manufacturer’s Installation Guidelines

Many window and door performance problems are related to installation issues. ***Installation directions included with window and door units should be carefully followed.*** In addition, installation practices should be periodically reviewed and issues identified for installer training as needed. Oftentimes, packaging can be checked after a job is underway or completed and various components intended by the manufacturer to provide moisture resistance, particularly for muller units, may be found in the packaging waste (e.g., gaskets, flashing components and clips). This is a good indication that installation training may be needed.

In addition, many units have weeps that allow water to discharge from the unit. These weeps should be free from construction debris and appropriately arranged relative to siding and flashing to drain water away from the wall. In the absence of relevant installation details for a specific application and combination of exterior envelope materials, the manufacturer should be consulted. In addition, industry standard installation guidelines may be consulted, such as ASTM E2112-01.

Tip Regarding Caulking of Nail Flanges

Caulking of nail flanges (particularly at the window head and jambs) is critical to the prevention of moisture intrusion around commonly used nail flange windows. This is particularly important if the flashing recommendations in Section 2.3.3 are not used. Thus, proper window flange caulking practices should be the subject of inspection and training during the installation process.

Field Test Repetitive Installations on Large Projects

Field testing of window and door products and their actual installation is one of the best ways to assess water resistance.

The tests may involve a simple water spray test like a garden hose, or use of a standard field test method such as ASTM E1105-00 “Field Determination of Water Penetration of Installed Exterior Curtain Walls and Doors by Uniform or Cyclic Static Air Pressure Difference.” If a simple hose spray test is used, keep in mind that the test should mimic realistic rainfall conditions or the results won’t be very meaningful. The more stringent ASTM field test is perhaps only justified on production home installation details that will be used repetitively. “Mock-ups” of details may also be used for this purpose (see ASTM E2099-00 in References). General guidance for evaluating water leakage problems as well as commissioning of building envelopes is also available (see ASTM E2128-01a and ASTM E241-00 in References).

Know How Windows and Doors Manage Water

There are marked differences in how window and door units manage water. Under wind-driven rain conditions, water will penetrate window frame crevices and seals between sashes and the frame. Under severe

conditions this water may even be forced through the window joints into the interior side of the window. Windows that perform best have adequate clearances between the sashes and frame to allow water to freely drain rather than becoming trapped. A minimum gap of about ¼" is recommended to prevent capillary action from holding moisture in locations where it can be driven by wind pressure differentials past seals and through frame joints. In addition, high performance windows have a system for weeping intruded water that acts much like a rainscreen wall system as discussed in Section 2.3.1. In severe wind-driven rain conditions (e.g., 'High' exposure condition as determined in Section 2.3.1) such high performance window and door systems should be preferred for the same reasons that cavity and rainscreen WRE systems are preferred. The above window and door frame detailing recommendations can generally be checked by inspecting the manufacturer's technical specifications showing a cross section of the unit including dimensions, seals, thermal breaks (if included), and other factors that may create leakage paths such as corner frame joints or muller joints in a multiple window assembly (see Figure 16).

Use Third-Party Certified Products

The level of performance and certification of window and door components varies a great deal. You typically get what you pay for. Current building codes generally require that window and glass door products comply with the 101/I.S.2/NAFS-02 Standard as verified and labeled by an independent certification agency and laboratory. Furthermore, products that do not fall within the scope of that standard are required to be at least tested in accordance with ASTM E330 for water and wind pressure resistance. Unfortunately, these standards do not necessarily require periodic sampling of production units and manufacturer quality control may vary. Using third-party certified

products, however, should reduce the likelihood of receiving substandard components. Various entities provide window and door certification and labeling services, such as the American Architectural Manufacturers Association (AAMA) and the Window & Door Manufacturers Association (WDMA).

Verify Wind Pressure and Impact Resistance Ratings

It is important to verify that glazing in windows and doors meets requirements for wind pressure loading. Wind pressure requirements are found in the local building code for the wind region (design wind speed) corresponding to the project location. Product labeling and certification should indicate the appropriate wind pressure rating. In areas that are identified as windborne debris regions (e.g., hurricane-prone coastal areas), the local building code may also require use of wind debris protection (e.g., shutters) or impact-resistant glazing. Such units are required to comply with ASTM E1886 and ASTM E1996 standards, which also should be indicated on product labeling and certifications. In many cases, field-supplied structural wood panel coverings with a suitable attachment method are acceptable. Impact-rated shutter systems (either manual or automatic) are also available.

REFERENCES AND ADDITIONAL RESOURCES:

101/I.S.2/NAFS-02, *Voluntary Performance Specifications for Windows, Skylights and Glass Doors*, American Architectural Manufacturers Association (AAMA) and Window and Door Manufacturers Association (WDMA)

ASTM E1105-00 *Standard Test Method for Determination of Water Penetration of Installed Exterior Windows, Skylights, Door, and Curtain Walls by Uniform or Static Air Pressure Difference*. American Society of Testing and Materials, www.astm.org

2.3.2 Window & Door Components

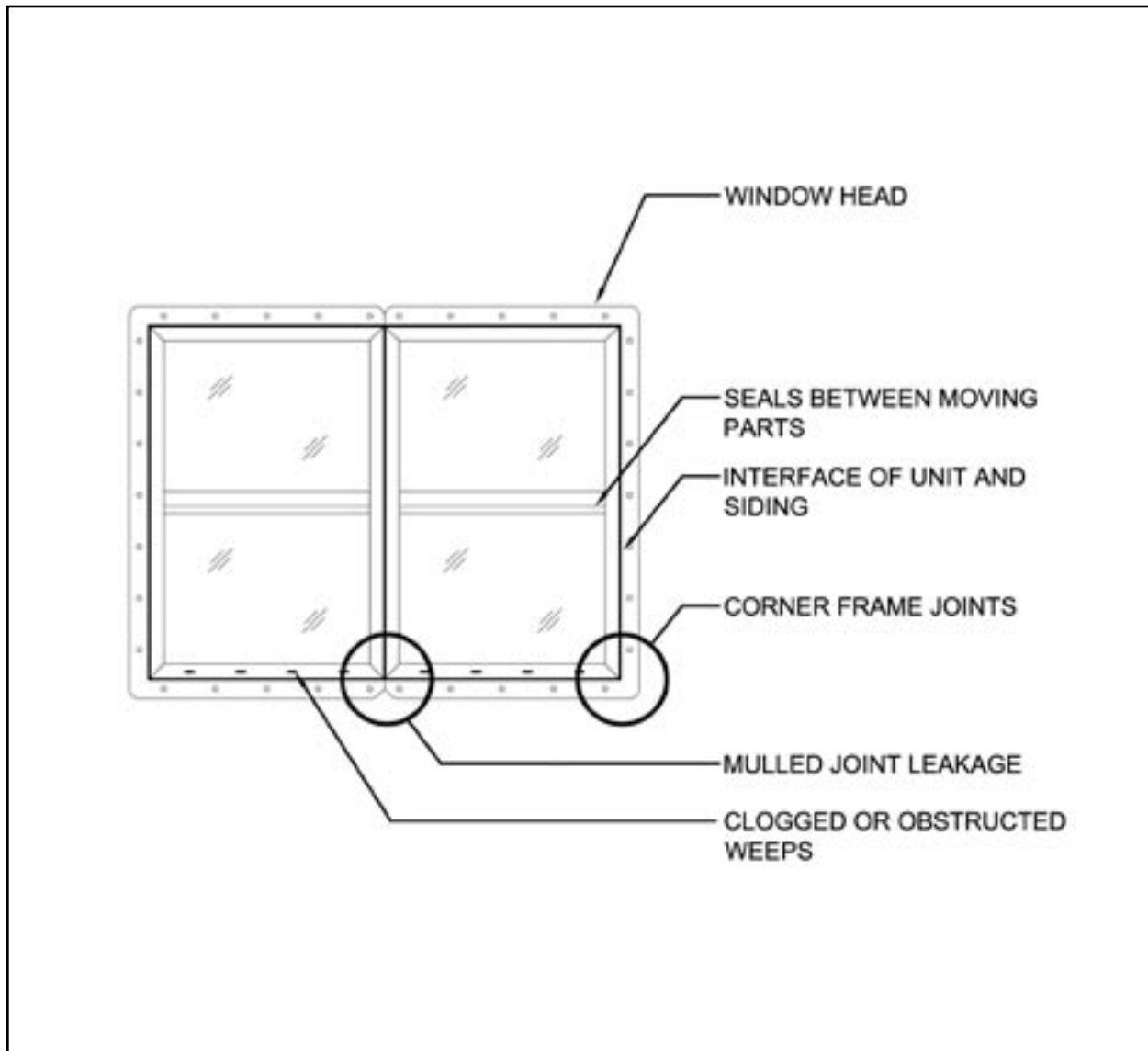

Figure 16 - Potential Window Unit Leakage Paths
(Similar leakage paths may apply to door units and door thresholds)

ASTM E1886-99 *Standard Test Method for Performance of Exterior Windows, Curtain Walls, Doors, and Storm Shutters Impacted by Missile(s) and Exposed to Cyclic Pressure Differentials*, American Society of Testing and Materials, www.astm.org

ASTM E1996-99 *Standard Specification for Performance of Exterior Windows, Glazed Curtain Walls, Doors and Storm Shutters Impacted by Windborne Debris in Hurricanes*, American Society of Testing and Materials, www.astm.org

ASTM E2128-01a *Standard Guide for Evaluating Water Leakage of Building Walls*, American Society for Testing and Materials, www.astm.org

ASTM E241-00 *Standard Guide for Limiting Water-Induced Damage to Buildings*, American Society for Testing and Materials, www.astm.org

ASTM E330-02 *Standard Test Method for Structural Performance of Exterior Windows, Doors, Skylights and Curtain Walls by Uniform Static Air Pressure Difference*, American Society for Testing and Materials, www.astm.org

Best Practice Guide: Wood Frame Envelopes in the Coastal Climate of British Columbia, Canadian Mortgage and Housing Corporation, April 9, 1997 (THIRD DRAFT), www.cmhc-schl.gc.ca

Kerr, D., *Keeping Walls Dry*, Canadian Mortgage and Housing Corporation, November 2004, www.cmhc-schl.gc.ca

Water Penetration Resistance of Windows – Study of Codes, Standards, Testing, and Certification, *Research Highlights*, Technical Series 03-125, Canadian Mortgage and Housing Corporation, November 2003, www.cmhc-schl.gc.ca

Woodframe Envelopes: Best Practice Guide, Canadian Mortgage and Housing Corporation, 2001, www.cmhc-schl.gc.ca

2.3.3 Flashing of Wall Components

OBJECTIVES: Water penetration and accumulation in walls is most commonly associated with flashing and detailing problems around windows, doors, and other penetrations through the weather-resistant wall envelope. This best practice provides recommended flashing details for common applications in residential construction and establishes basic concepts to use in other applications. These points are intended to enhance or help fulfill the basic objective for flashing of the weather-resistant wall envelope as found in the 2003 IRC:

R703.8 Flashing. Approved corrosion-resistant flashing shall be provided in the exterior wall envelope in such a manner as to prevent entry of water into the wall cavity or penetration of water to the building structural framing components. The flashing shall extend to the surface of the exterior wall finish and shall be installed to prevent water from re-entering the exterior wall envelope. Approved corrosion-resistant flashings shall be installed at all of the following locations:

1. At top of all exterior window and door openings in such a manner as to be leak proof, except that self-flashing windows having a continuous lap of not less than 1-1/8 inches (28 mm) over the sheathing material around the perimeter of the opening, including corners, do not require additional flashing; jamb flashing may also be omitted when specifically approved by the building official.
2. At the intersection of chimneys or other masonry construction with frame or stucco walls, with projecting lips on both sides under stucco copings.
3. Under and at the ends of masonry, wood or metal copings and sills.

2.3.3 Flashing of Wall Components

4. Continuously above all projecting wood trim.
5. Where exterior porches, decks or stairs attach to a wall or floor assembly of wood-frame construction.
6. At wall and roof intersections.
7. At built-in gutters.

PRECAUTIONS: Model U.S. building codes provide only general requirements for use and detailing of flashing. Therefore, it is imperative that designers and builders consider this issue in detailing construction plans, reviewing installer training, coordinating different trade contractors, and inspecting jobsite work. In addition, do not depend on caulk where flashing is feasible. Where caulking is unavoidable or necessary, refer to Section 2.3.4.

BEST PRACTICE:

Specify Flashing Details for All Windows, Doors, and Ledgers

In Figures 17 through 22 some typical – yet very important – flashing details are provided as general models for correct installation techniques. These are not presented as the only solution to flashing, because there are certainly many other viable solutions, but as examples of workable approaches to protecting shell penetrations from water intrusion.

Window flashing and deck ledger flashing are essential in preventing water damage to wall assemblies. The kick-out flashing detail in Section 2.2.2 is also an important flashing consideration to protect against water intrusion. A variety of manufactured window sill and door threshold flashing components (e.g., pre-molded pan flashings) are also available in lieu of site-built flashing components featured in this section. These

components are to expel any water leakage at the base of windows and doors. Flashing recommendations that address different building conditions can be found in the Energy and Environmental Building Association's (EEBA) *Water Management Guide* and various other industry resources (see References).

ILLUSTRATED BEST PRACTICE:

Figures 17 and 18 illustrate window flashing details that can be used depending on when windows are installed related to the envelope weather barrier (e.g., house wrap or building paper).

In Figure 19, the enhanced flashing details at the jamb and the sill are designed to provide enhanced protection against water intrusion in more severe weather conditions.

REFERENCES AND ADDITIONAL RESOURCES:

ASTM 2112-01 *Standard Practice for Installation of Exterior Windows, Doors, and Skylights*. American Society of Testing and Materials, www.astm.org

Avoiding Moisture Penetration in Walls, Build a Better Home®, Form No. A530, APA The Engineered Wood Association, Tacoma WA, 2001, www.apawood.org

Durability by Design: A Guide for Residential Builders and Designers, U.S. Department of Housing and Urban Development, Washington DC, 2002, www.huduser.org

International Residential Code (IRC), International Code Council, Inc., Falls Church VA, 2003, www.iccsafe.org

Lstiburek, J.W., *EEBA Water Management Guide*, Energy and Environmental Building Association, Minneapolis MN, 2004, www.eeba.org

2.3.3 Flashing of Wall Components

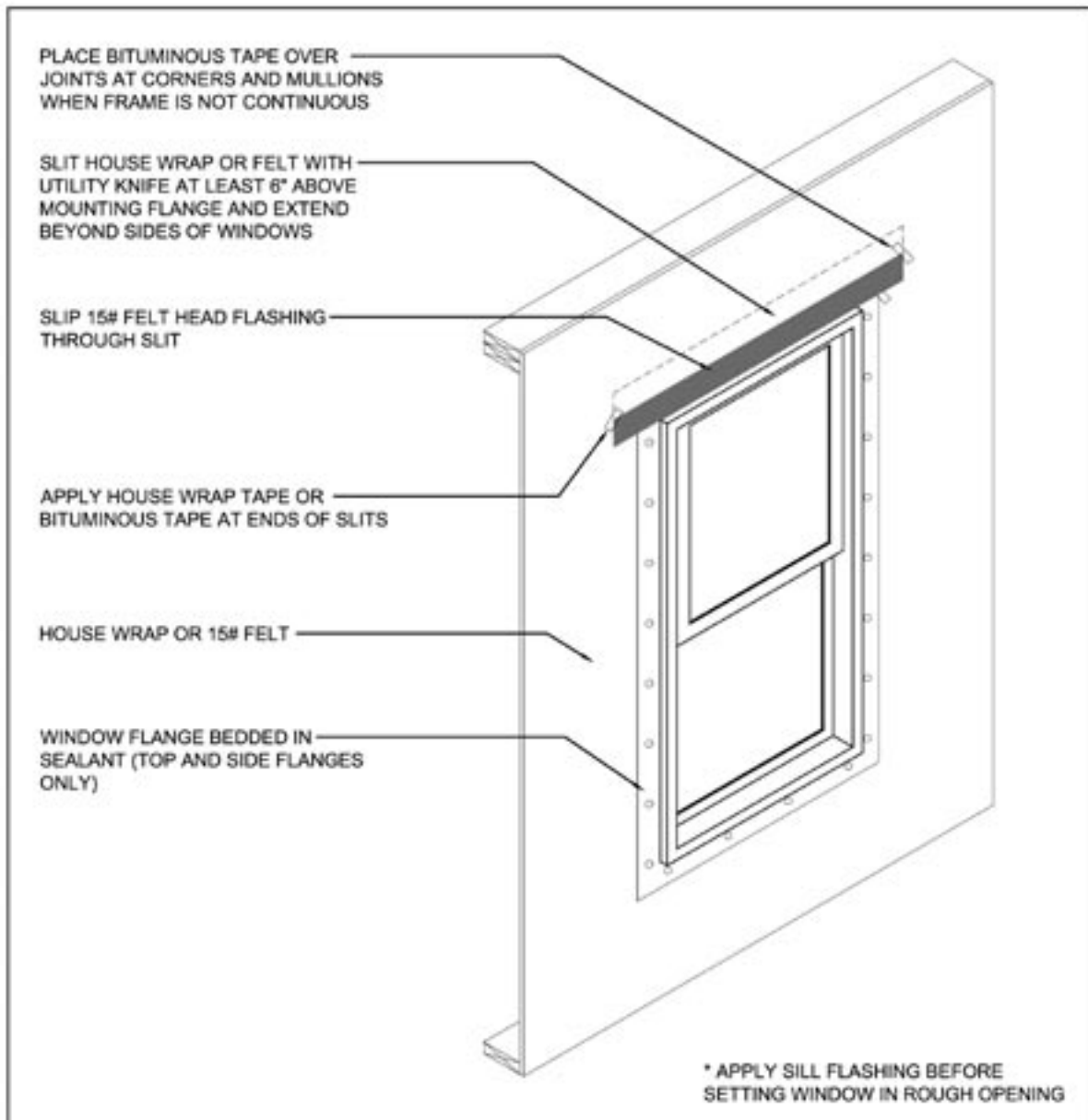

Figure 17 - Basic Window Flashing
(Weather barrier installed **before** window)

2.3.3 Flashing of Wall Components

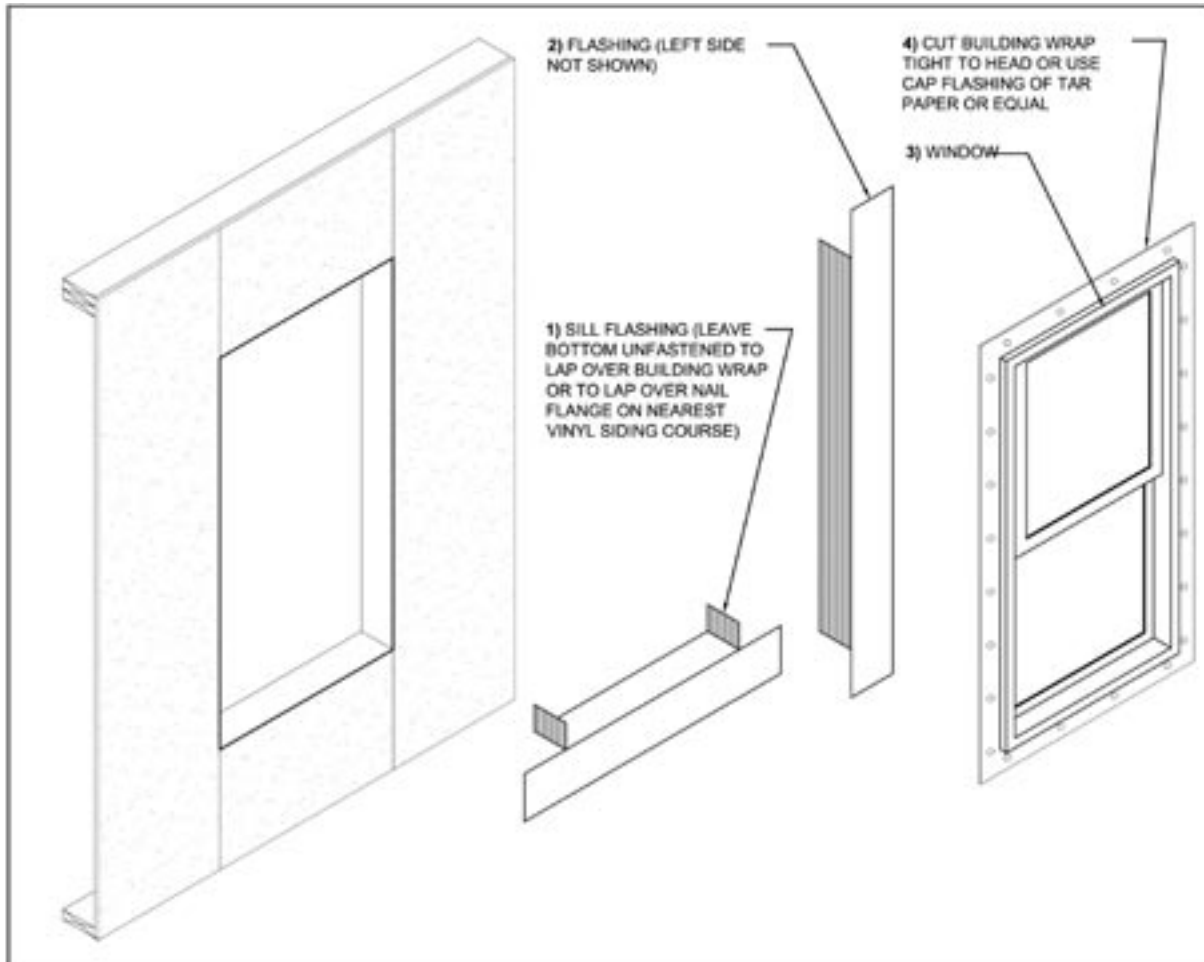

Figure 18 - Window Sill and Jamb Flashing
(Weather barrier installed after window)

2.3.3 Flashing of Wall Components

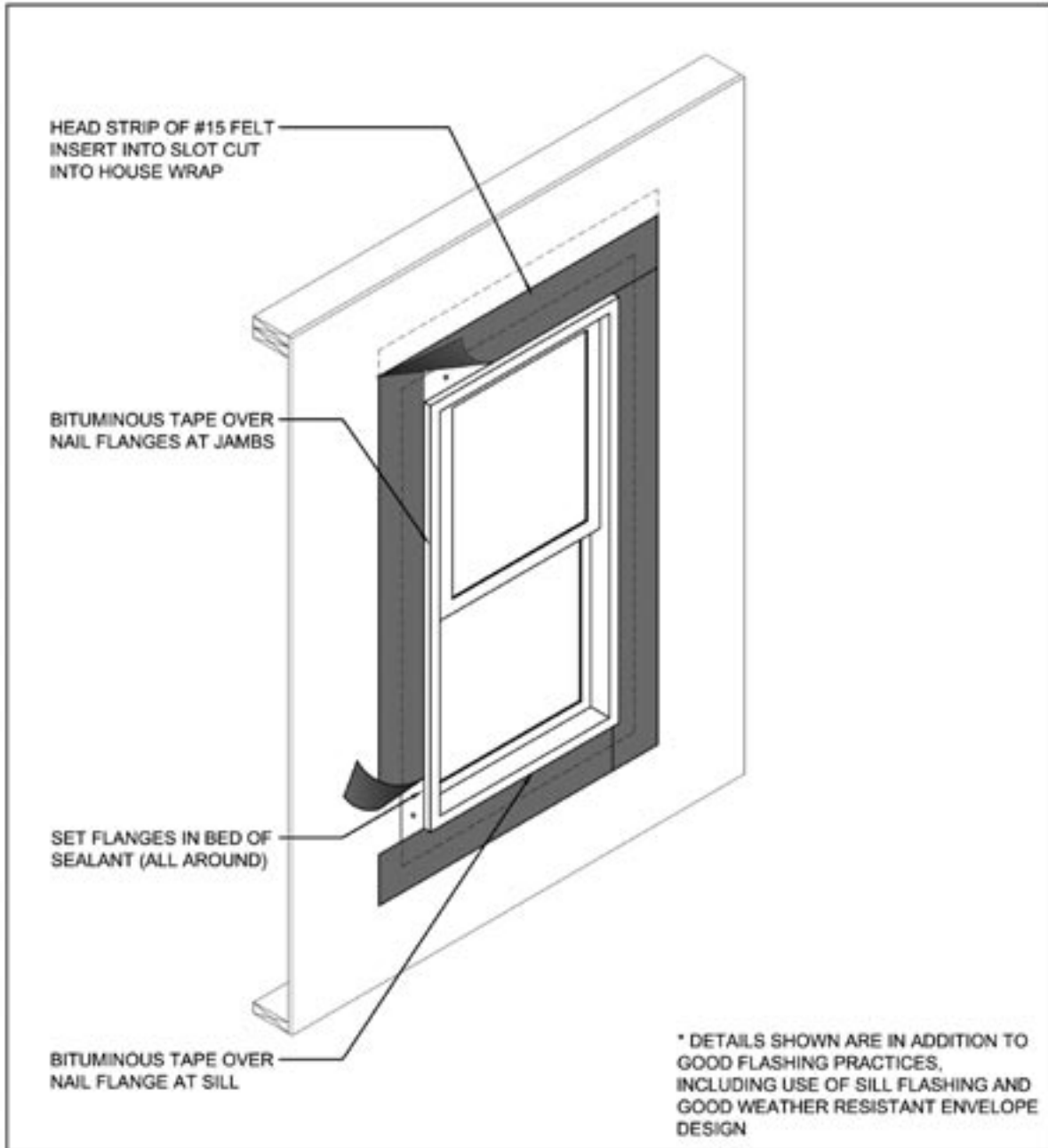

Figure 19 - Window Flashing for Severe Weather

2.3.3 Flashing of Wall Components

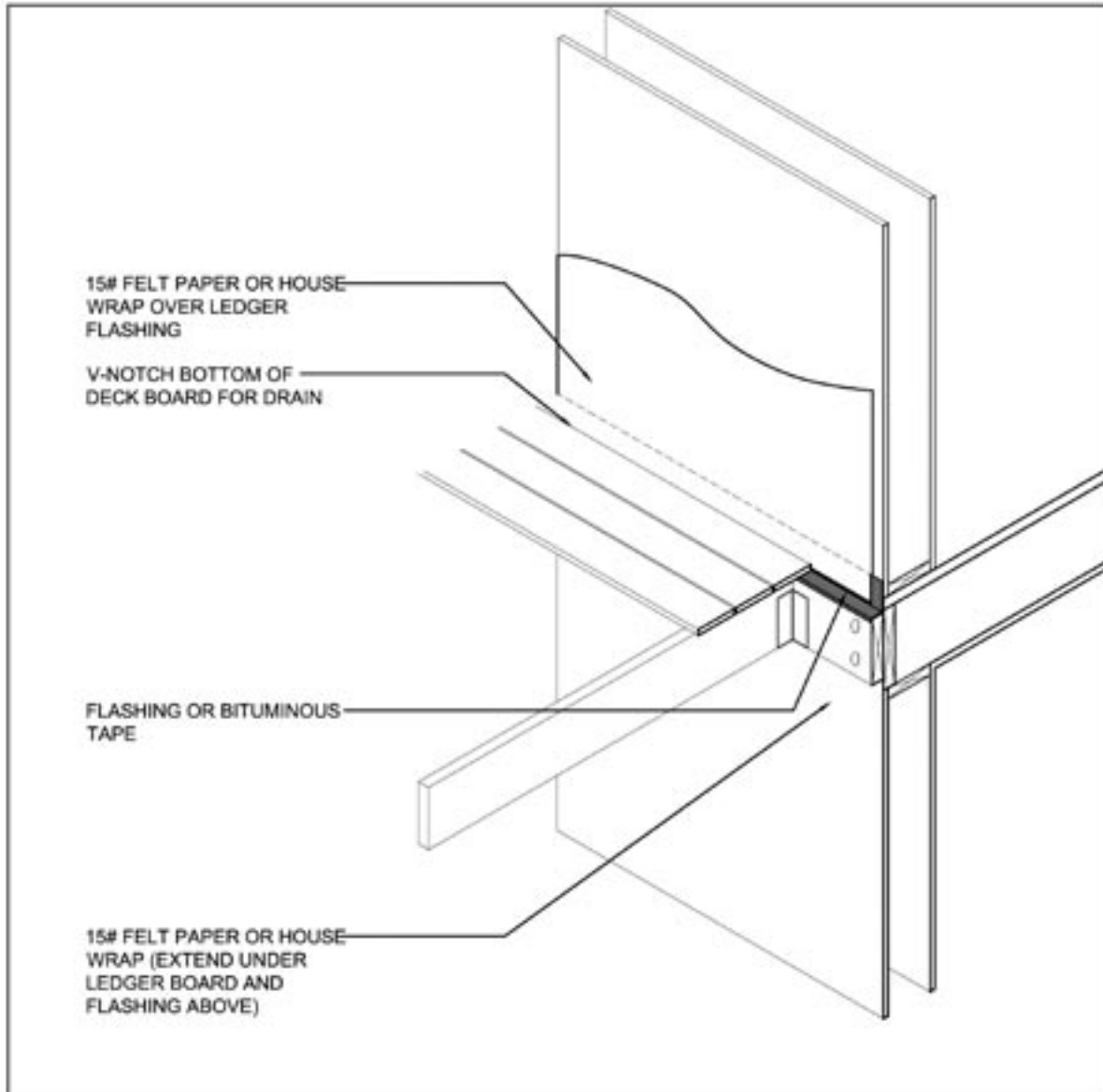

Figure 20 - Deck Ledger Flashing Detail

2.3.3 Flashing of Wall Components

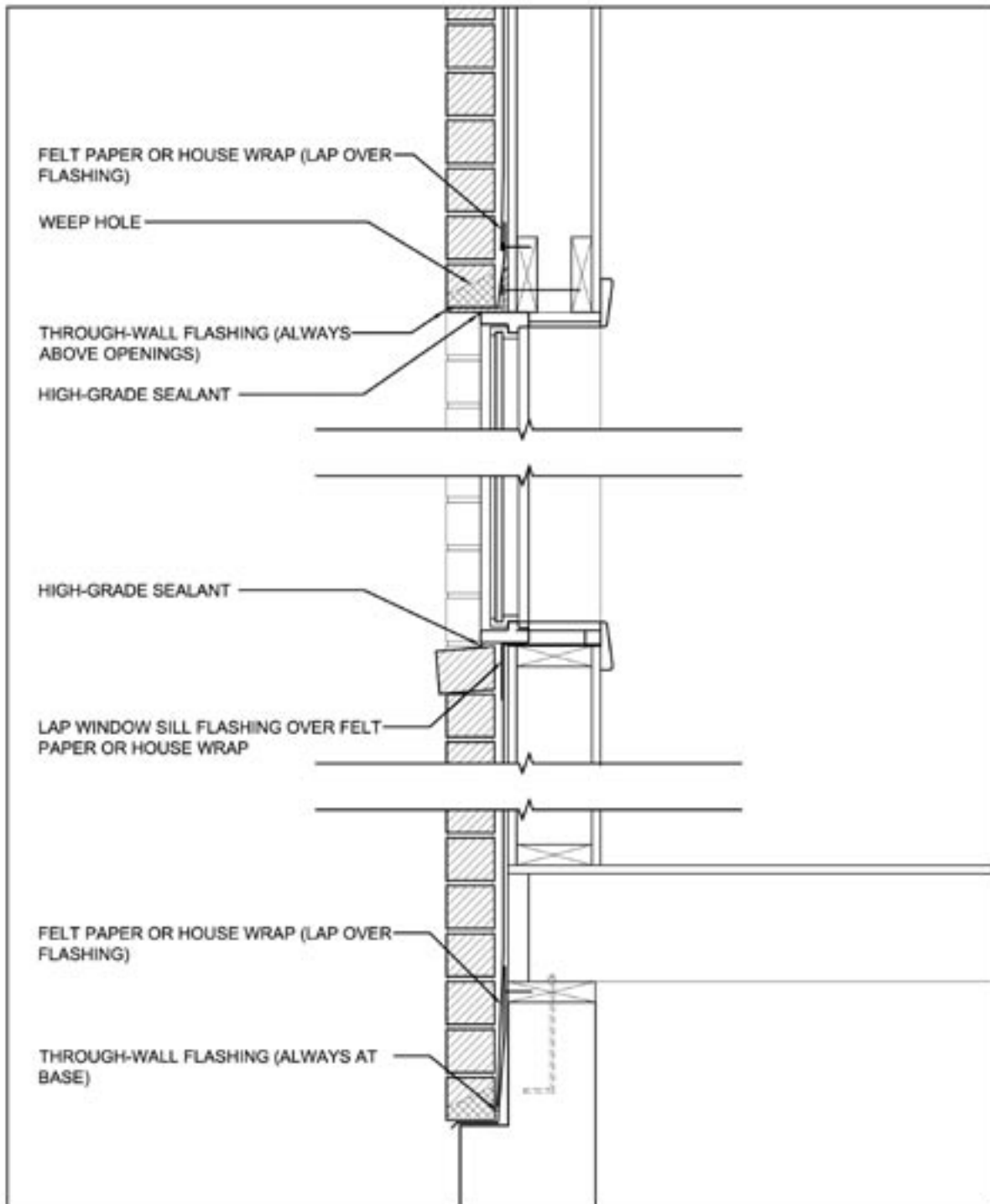

Figure 21 - Typical Brick Veneer Flashing Details

2.3.3 Flashing of Wall Components

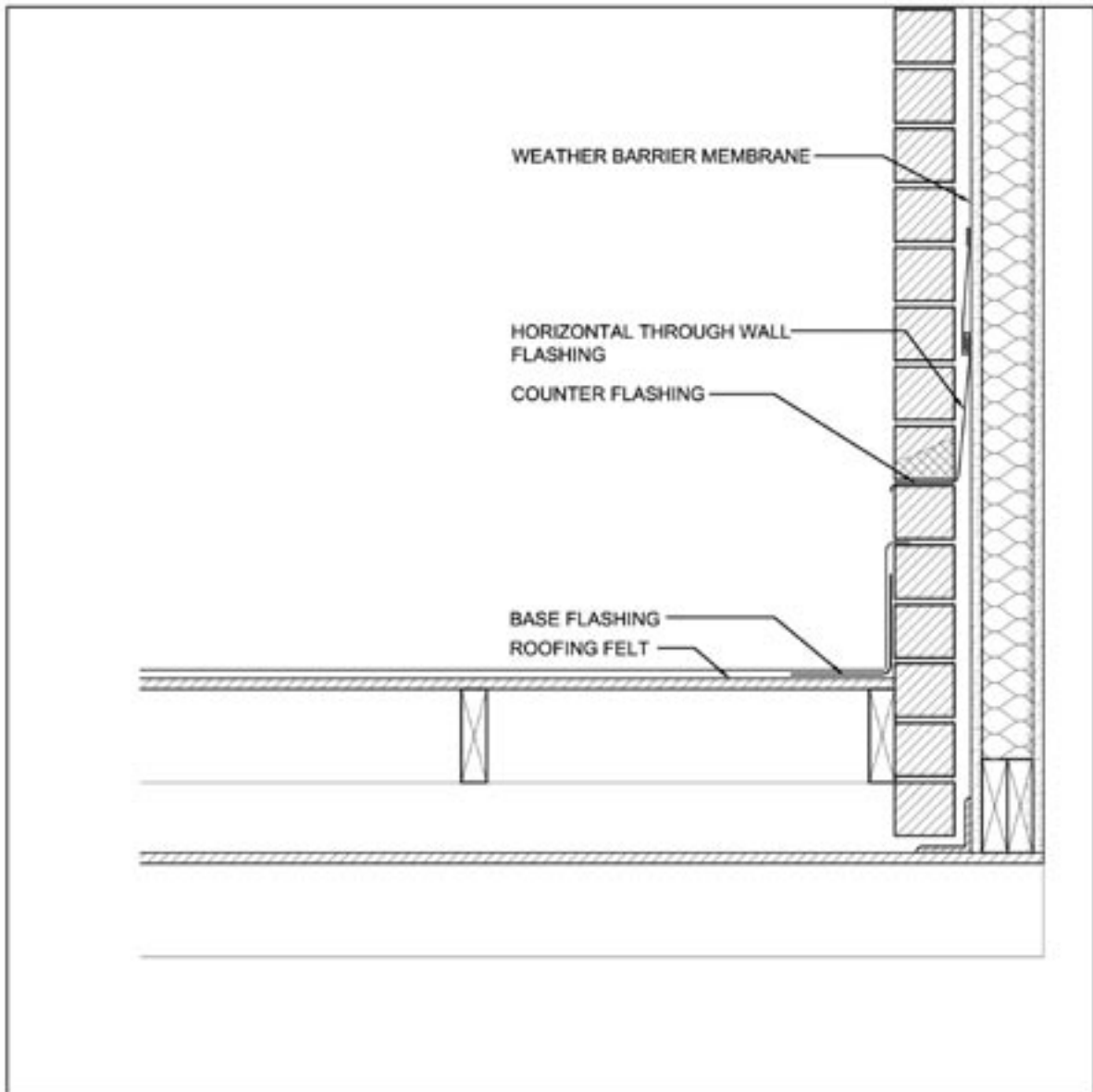

Figure 22 - Brick Veneer Flashing at Roof Intersections

2.3.4 Caulks and Sealants

2.3.4 Caulks and Sealants

OBJECTIVES: In construction of the weather-resistant envelope (WRE) system, there will be joints and seams that require or benefit from the appropriate use and maintenance of caulks and sealants. In the absence of guidelines for specification and application of caulk or sealants in model building codes, this section provides best practice recommendations regarding their use. Where caulk is required by manufacturer installation instructions, the specified caulk materials and methods should be carefully followed.

PRECAUTIONS: In general, avoid relying on caulks and sealants as the primary defense

against water intrusion at joints in the WRE system. Flashing is preferred wherever feasible - even when caulk is additionally used (see details in Section 2.3.3). Using normal quality caulk and installation practices, combined with the shrinkage and swelling of building components, usually results in the onset of gradual failure of a water tight seal within a few years.

For face-sealed WRE systems (see Section 2.3.1), the appropriate sealant specification and installation is critical. Refer to and carefully follow cladding and sealant manufacturer recommendations and be sure to specify window and door components (drainage features and frame materials)

Table 9 - Caulk Characteristics and Application Recommendations

CAULK CHARACTERISTICS AND APPLICATION RECOMMENDATIONS ^a											
Caulk	Life (Yrs)	Best Uses	Adhesion	Shrink-free	Primer Use ^b	Joint Type	Back-free (hrs)	Cure (Days)	Clean up ^c with ^d	Paint	Available Colors
Oil-base	1-7	not desirable	fair-good	poor	porous surfaces	non-moving to 1/2" w x 1/2" d	2-24	to 365	paint thinner	must	white, natural gray
Acrylic-latex	2-10	indoors, protected, or painted	excellent, except metal	fair	porous surfaces for best results	non-moving to 1/2" w	1/2 - 1/2	3	water	best	white, black, gray, bronze
Butyl rubber	7-10	narrow openings in wood, metal, glass, masonry	very good	fair	none needed	non-moving up to 1/2" x 1/2"	1/2 - 1 1/2	7	paint thinner, naphtha	best	white, clear, gray, black, brown, redwood, beige, bronze, sandstone
Polysulfide rubber	20+	anywhere	excellent	excellent	special primer on all but metal	all up to 1/2" x 1/2"	24-72	7	TCE, toluene, MEK	if desired	white, black, gray, limestone, bronze
Silicone rubber	20+	outdoor metal, heat ducts, shallow joints	good, excellent with primer	excellent	porous surfaces	all from 1/2" d	2-5	2-5	paint thinner, naphtha, toluol, xylol	read label	brown, white, black, clear, gray
Urethane	20+	anywhere	excellent	excellent	none needed	all to 1/2" x 1/2"	4-14	4-14	MEK, acetone, lacquer thinner	if desired	white, gray, black, limestone, bronze, special colors
Weatherstrip/caulking cord	to 20	temporary draft sealing and hole plugging	none	excellent	none needed	non-moving	-	none	not sticky	no	clear, gray

Sources: Structures and Environmental Handbook, Eleventh Edition (Midwest Plain Service, 1983)

Table Notes:

- This table is intended as a general guide. Manufacturer's sealant application and installation recommendations should be consulted.
- Life expectancy estimates are based on ideal conditions with high quality installation.
- "Porous" includes wood, wood products, concrete, and brick.
- MEK - methyl-ethyl-ketone, TCE - trichloroethylene

that are compatible with face-sealed WRE applications as well as the specified caulk. For example, welded seam aluminum window frames with exterior drainage and internal pressure equalization features are commonly used in commercial building applications with face-sealed WRE systems.

BEST PRACTICE:

Use Appropriate Sealants and Installation Practices

Some general recommendations regarding the selection of caulks and sealants are provided in Table 9, including longevity, the best uses, and the appropriate types of joints for given sealants. With good adherence to the manufacturer's instructions - particularly with respect to surface preparation - high quality caulks and sealants can be made to endure for a reasonable time between maintenance and replacement (i.e., up to 5 years or considerably more when not severely exposed). Silicone rubber and urethane caulks generally give the best overall performance for exterior building envelope applications. For bath and shower applications, mildew-resistant silicone caulks are also available.

In addition, caulks and sealants should be stored in a warm environment and should not be stored for more than a couple of years before use. A high quality caulk installation requires appropriate ambient temperature, dry and clean surfaces, and an adequate joint gap to allow the caulk to act elastically without pulling loose from the two caulked parts. In addition, foam backer rod or bond-breaker tape may be needed to create an appropriate caulk joint profile for adhesion, flexibility, and durability. The References section contains several resources with detailed guidance on creating well sealed joints. Finally, the need for homeowner inspection and replacement of caulking must be strongly emphasized.

REFERENCES AND ADDITIONAL RESOURCES:

ASTM C1193-00 *Standard Guide for Use of Joint Sealants*, American Society of Testing and Materials, www.astm.org

Best Practice Guide: Wood Frame Envelopes in the Coastal Climate of British Columbia, Canadian Mortgage and Housing Corporation, April 9, 1997 (THIRD DRAFT), www.cmhc-schl.gc.ca

Durability by Design: A Guide for Residential Builders and Designers, U.S. Department of Housing and Urban Development, Washington DC, 2002, www.huduser.org

Forgues, Y.E., "Properly Sealed Construction Joints," *Construction Practice*, Institute for Research in Construction, National Research Council Canada, http://irc.nrc-cnrc.gc.ca/practice/sea2_E.html

O'Connor, T.F., "The One Percent of Cost That Can Become 90 Percent of Trouble," *ASTM Standardization News*, American Society of Testing and Materials, West Conshohocken PA, June 2003

2.4 Best Practices for Moisture-Resistant Foundations

2.4.1 Site Planning & Foundation Design Considerations

OBJECTIVES: This best practice provides guidance for a number of building site considerations that are important to providing moisture-resistant homes. Considering the moisture and drainage conditions at a proposed building site (or at an existing building site) is the first and perhaps most important step in providing for moisture-resistant foundations. Building foundations

should be located on sites in a manner that prevents moisture problems by providing for adequate drainage of on- and off-site surface water flows, including roof water run-off. Ground water conditions should also be considered. Selection of an appropriate foundation type, foundation elevations, and foundation moisture-resistant detailing are related factors that are dependent on a number of site considerations.

PRECAUTIONS: The need for a detailed site exploration to direct building foundation planning is often overlooked or downplayed. In part, this may be because many sites are considered “normal” and fall within standard conditions addressed in the residential building code. However, *the use of marginal sites – which is becoming more and more common - without the proper site exploration to inform design decisions (e.g., foundation type and detailing), can result in costly mistakes such as foundation structural and moisture problems.* At a minimum, the “quick screening” process laid out in this section should be used and a site plan should always establish appropriate foundation elevations and drainage patterns for the site.

BEST PRACTICE:

Create a Workable Site Drainage Plan

A site plan should be developed to do more than just locate the building and utilities on the site and demonstrate compliance with setbacks and other zoning requirements. The site plan should also consider a drainage plan that indicates the slope of land and drainage patterns that convey surface waters from the building site. For sites that generally provide natural drainage away from the building location, the main concern is establishing an appropriate foundation elevation to maintain drainage immediately adjacent to the foundation.

Model building codes typically require a minimum of 6” of fall in ground level over a distance of 10 feet from the perimeter of the building. Providing for additional slope is a good method to offset future settlement of foundation backfill next to the building (unless the soil is moderately compacted or tamped during the backfill process).

Conditions that should warrant careful consideration on any site include:

- high local water table (e.g., within 4 to 8 feet of the lowest proposed foundation floor/grade level)
- natural depressions that collect or channel on- and off-site flows
- springs or wet areas on site
- “soft” or “loose” soils indicative of poor bearing capacity
- development that will result in more than 10 to 20 percent impervious area coverage on the site
- steep slopes that may be unstable or easily eroded (e.g., greater than 25 percent slopes)
- signs of existing erosion (gullies, slope failures, etc.)
- sensitive areas that may be impacted by proposed development (e.g., natural streams, wetlands, or other features)
- off-site surface water flows directed onto and across the proposed site
- inadequate building offset from adjacent steep slopes that generate increased surface water run-off (a minimum offset of 15 feet from the toe of a 1:3 (33 percent) or greater slope is generally recommended, but special conditions may warrant a greater or lesser amount of offset)
- 100-year flood plain located on site or near building location

2.4.1 Site Planning & Foundation Design Considerations

Poor site drainage of surface water is perhaps the most important contributor to foundation moisture problems. Thus, the above types of factors should be considered at an early stage in any land purchase or building planning process. If a given site is already selected, then the issue becomes one of proper site preparation (grading and drainage) and foundation design (selection of foundation type, drainage details, and moisture-proofing practices) to meet the conditions presented by the site. Wetness of the site, soil bearing conditions, and slope of the site are key

factors in making a decision on whether to build or not, and how to build. *When poor site conditions exist, they can often be overcome technically (provided there are not land-use restrictions involved). However, the added cost of design and non-conventional foundation construction (e.g., elevated foundation and/or special drainage features) should be considered as an important part of the overall project expense.* It is usually very costly to correct site drainage problems and foundation moisture issues after the fact.

ILLUSTRATED BEST PRACTICE:

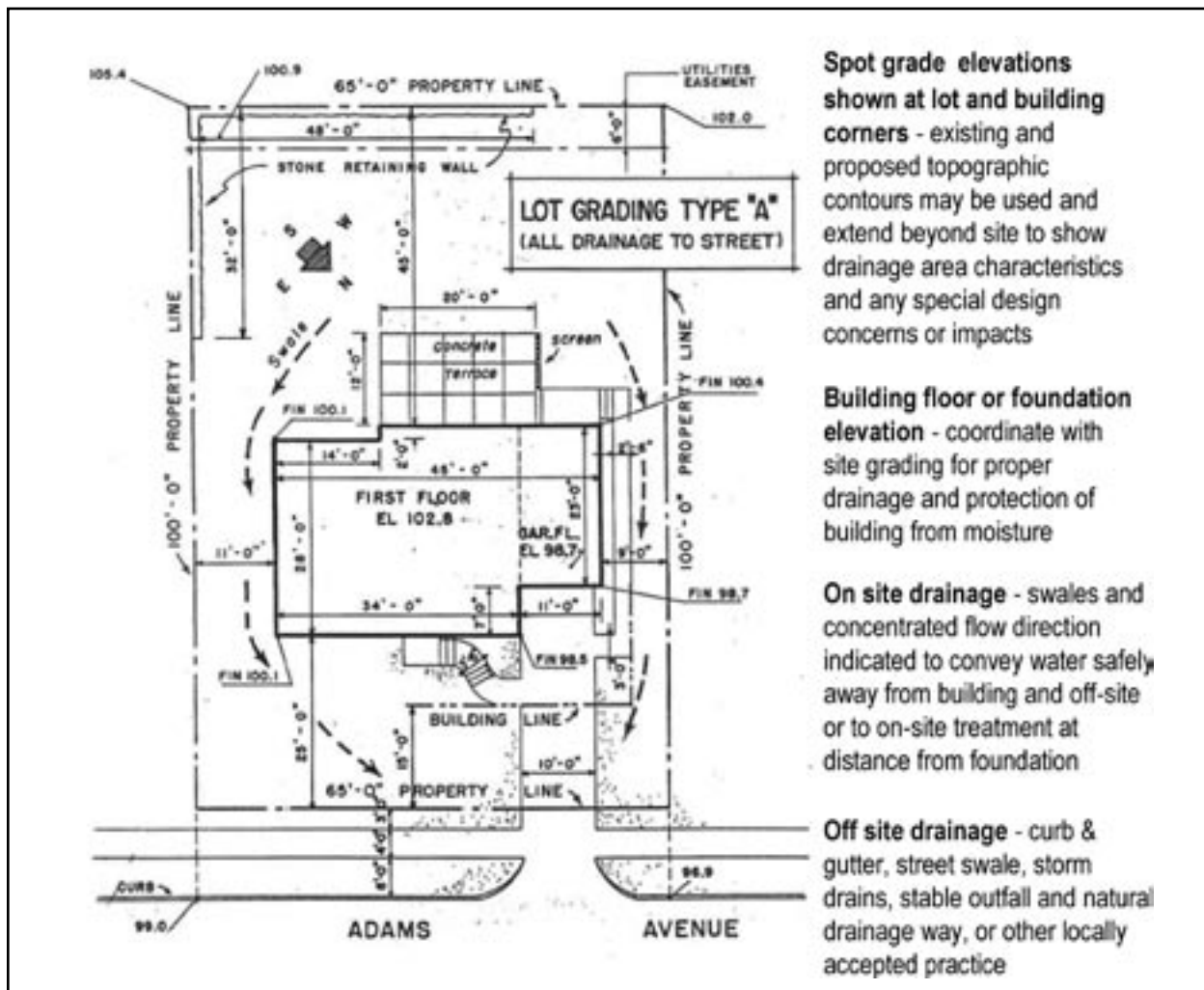

Figure 23 - Site Drainage Plan Considerations (Single Lot)

SCREENING A SITE

Fortunately, a site's propensity for moisture problems can be screened relatively quickly by:

- Interviewing adjacent and/or previous property owners
- Conducting a site exploration including shallow soil borings to assess soil bearing strength and water table to several feet below the proposed foundation depths
- Understanding the history of local foundation practices used in the vicinity of the proposed site
- Reviewing publicly available Soil Survey reports published by the USDA Natural Resources Conservation Service (formerly Soil Conservation Service); these reports from the Soil Data Mart (<http://soildatamart.nrcs.usda.gov/>) are published for most counties and address soil characteristics and provide general land use recommendations
- Reviewing local topography for drainage patterns (e.g., USGS topographic maps, available for free on www.topozone.com)
- Observing the site during or immediately following a significant rainfall event that produces excess rainfall

In one builder survey, about 75 percent of builders that reported basement leakage problems had not conducted water table tests prior to construction.

If any initial screening observations indicate the potential existence of site conditions mentioned previously, the site should be more carefully investigated by a geotechnical engineer or other qualified professional familiar with local building practices and ground conditions. The foundation plan should be based on the results of the findings. For a site considered to be nor-

mal (absent of the conditions mentioned previously), minimum foundation moisture-resistant practices in modern building codes are usually adequate. The best practices featured later in this section will provide enhanced performance in comparison to minimum accepted practices for foundation design.

REFERENCES AND ADDITIONAL RESOURCES:

Basement Water Leakage...causes, prevention, and correction. National Association of Home Builders, Washington DC, 1989

Durability by Design: A Guide for Residential Builders and Designers, U.S. Department of Housing and Urban Development, Washington DC, 2002, www.huduser.org

Land Development Handbook, 2nd Edition. The Dewberry Companies, McGraw-Hill, 2002

Steps to Constructing a Moisture-Resistant Foundation, Build a Better Home®, Form No. A520, APA—The Engineered Wood Association, Tacoma WA, 2001, www.apawood.org

2.4.2 Basement Foundation Construction

OBJECTIVE: Basement moisture problems are a frequent moisture problem in home building. Even in some of the driest of site conditions, foundations are continually exposed to moisture vapor from the ground. When basements are used inappropriately on sites with high ground water or in areas with intermittent periods of higher ground moisture levels due to rainfall and water table fluctuations, they are frequently exposed to bulk water. Therefore, foundations must be detailed to deal with the potential for water leakage through cracks and joints, capillary movement of water through foundation materials, vapor transmission of moisture through foundation materials, and condensation of moist air on

cool foundation surfaces. The degree of protection required for any given site and selected foundation type is primarily one of judgment in meeting or exceeding minimum building code requirements. The best practice recommendations in this section are intended to provide enhanced moisture-resistance based on experience and current expert opinion. The recommendations are collectively applied in Figure 24. Interior finishing and insulation of basement walls is addressed in Section 2.4.3.

PRECAUTIONS: The use of foundations that create below-ground spaces on wet sites should be avoided, rather than attempting to remedy the problem by painstaking water-proofing efforts that may have a shorter life than the building. As a rule-of-thumb, moisture protection of foundations should err on the conservative side when there is reasonable doubt as to the moisture conditions on site. The moisture-resistant practices presented in this guide are quite inexpensive compared to the cost of correcting moisture problems after construction is complete. They also reduce the risk of moisture problems in other parts of the building by protecting a prominent entry point for moisture—the foundation.

ILLUSTRATED BEST PRACTICE:

Figure 24 and the following sections highlight best practices for moisture-resistant basement foundations.

BEST PRACTICES:

Provide Increased Drainage Slopes Away from the Foundation and Use Good Backfill Practices

Proper grading to provide positive flow of surface water and roof water run-off (gutter discharge) is one of the simplest and most

important features on a building site. ***When possible, the minimum 6" fall in finish grade over a distance of 10 feet from the building (minimum 5% slope) should be exceeded and extended. This is particularly important if backfill practices are not reasonably controlled to prevent settlement.*** On very flat sites this may require “mounding” of the foundation pad and coordination of appropriate foundation elevations to promote drainage. On sloped sites, excavation and grading in the up-slope direction must provide for sufficient drainage away from the building perimeter and against the direction of natural water flow on the site. For sites with very steep slopes, this may require use of a retaining wall at the toe of a steep slope.

Backfill soil should be placed in a manner that prevents settlement and potential surface water flow toward the foundation. This may require that backfill soil be placed in 6" to 8" layers or “lifts” and modestly compacted with light construction equipment or tamped to prevent settlement over time. Heavy compaction effort

Backfill & Site Grading Problems Make for Wet Basements

In one survey of basement leakage problems, about 85% of the moisture problems appeared only after rain storms or melting snow – a strong indication of the importance of site drainage in preventing foundation moisture problems. Of these incidences of basement leakage problems, about 40% were associated with improper surface grading; 25% were related to improper downspout drainage; and another 25% were associated with settling of backfill resulting in improper surface grading after passage of time (often within the first year after construction). Thus, a majority of basement water problems are associated with backfill and site grading. For recommendations regarding roof guttering and downspout discharge away from the foundation, refer to Section 2.2.5.

2.4.2 Basement Foundation Construction

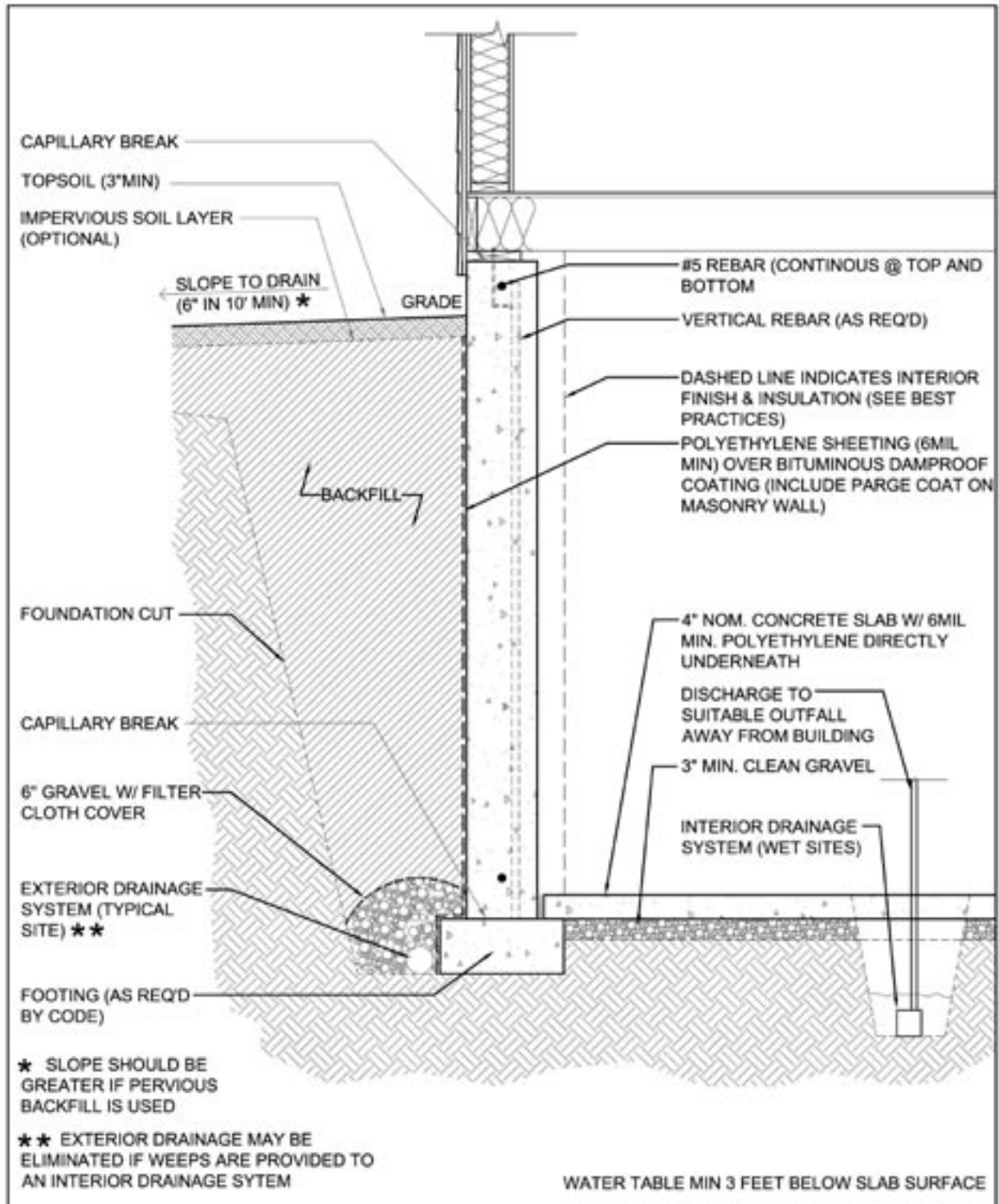

Figure 24 - Basement Foundation Detail

2.4.2 Basement Foundation Construction

(typical to commercial building or roadway construction) should **not** be promoted as this may damage typical residential foundation walls. The goal is to compact sufficiently to prevent future settlement from the process of natural consolidation of loosely placed soil. In addition, backfill should not be placed without first installing the floor system (or temporary bracing) to support the foundation walls.

Finally, the upper layers of the backfill should be of moderately low-permeability soil (e.g., with some clay content) to help reduce the direct infiltration of rainwater adjacent to the foundation. ***Where only pervious soils are available for backfill, the slope of grade away from the perimeter of the foundation should be increased or an impervious “skirt” of 6 mil polyethylene may be placed about 12” below grade.***

Include Backfill Specifications on Plans

It is notoriously difficult to control grading and backfilling operations in typical residential construction. On many sites the common practice is to place the backfill with the least amount of effort required to “fill the hole.” ***Therefore, backfill specifications should be shown on the plans as well as in foundation contractor agreements.*** Backfill and grading should also be inspected for compliance with the plans. Proper backfill practices and grading will ensure that a foundation remains dry to a greater degree than all other recommendations in this section of the guide.

Foundation Drainage Systems

Foundation drainage serves a number of roles. First, it removes “free water” from the foundation perimeter - which reduces the lateral (sideways) load on the foundation wall. It also lowers the ground water level in the vicinity of the building footprint should it become elevated above the basement floor level during a particularly wet season or year. (Remember, basements should

not be used where ground water levels are frequently near to the basement floor level – see Section 2.4.1).

Current model building codes require that drains be provided around all foundations that enclose habitable space (such as basements). However, exceptions are made for soils that are naturally well drained.

Unless a site-specific soil investigation is done or extensive local experience confirms that ground water levels are consistently deep, soils should not be assumed to be well drained.

Where the foundation drainage system cannot be drained to “daylight” by gravity, a sump and pump must be used to collect the water and discharge it to a suitable outfall (e.g., rock pad and swale) a safe distance away from the building foundation. Furthermore, use of a drainage layer underneath the entire basement floor slab (coupled with weeps to a drainage system around the outside perimeter of the foundation) may be a more effective way to eradicate conditions where potential for high ground water levels (near to the basement floor elevation) may exist. Experience has shown that trying to seal moisture out of a foundation is not nearly as effective as diverting the moisture with a drainage system before it gets inside the living space.

Waterproofing vs. Damp-proofing

Model building codes typically require only damp-proofing of foundation walls in “normal” site conditions. Damp-proofing involves applying a bituminous coating material on the exterior surface of the foundation wall. The use of waterproofing measures is reserved for conditions where “high water table or other severe soil-water conditions are known to exist.” Strictly speaking, waterproof does not mean water tight (as with a boat hull). It simply involves the application of a more

Using 6-mil Poly for Water-Proofing

The use of 6 mil poly as a water-proofing membrane on basement foundations helps to bridge small cracks and also minimizes the rate of moisture transport through the foundation wall by means of capillary action and vapor transmission. These sources of moisture transport add to moisture levels inside the basement and above grade portions of the home. For these reasons, in an NAHB survey of foundation construction practices and moisture-related problems, basement walls with a 6 mil poly covering were 11 times less likely to experience leakage problems in comparison to typical damp-proofing practices! (*Basement Water Leakage...Causes, Prevention, and Correction*. National Association of Home Builders, 1978).

impermeable membrane on the foundation wall (e.g., 6 mil poly or various other water-proof membrane materials).

In this guide, the waterproofing method is recommended as a best practice, especially if the basement is intended to be used for storage or living space.

Waterproofing involves the simple application of damp-proofing, plus a layer of 6 mil poly on the exterior below-grade portions of a basement foundation wall. Other single-ply or built-up membranes may also be used.

Foundation Crack Control

It is important to realize that all concrete and masonry construction will develop cracks due to shrinkage effects. As these cracks widen over time (usually due to small amounts of differential settlement in the soil supporting the foundation), the pathways for water intrusion through the foundation increase. Visible cracks also become a concern to homeowners even though they often have

little relevance to the structural integrity of the foundation. The question becomes how to best control these cracks.

The optimum location for reinforcement to control cracking and prevent differential settlement is at the top and bottom of the foundation wall in a horizontal direction.

Horizontal reinforcing of this type should be considered in addition to adhering to code-required vertical reinforcement. By placing horizontal reinforcement, the wall acts as a “deep beam” even after cracks initially form due to shrinkage effects during the concrete curing process. If the wall is adequately tied (or doweled to the footing) then the reinforcement in the bottom of the wall may be placed horizontally along the length of the footing. The reinforcement at the top of the wall is known as a bond beam in masonry construction. Alternatively, truss-type reinforcing wire may also be used between horizontal courses of masonry block.

Sealants for Through-Wall Penetrations

Utility penetrations through foundation walls should be carefully sealed on the exterior face of the wall prior to placement of water-proofing materials and backfill.

High quality urethane caulks are most suitable for this application (refer to Section 2.3.4 for additional guidance on use of sealants). In

Good Concrete Practice Results in Water-Resistant Concrete

Good concrete construction practice is also important to minimize foundation cracking and porous concrete (voids) that will allow greater potential for foundation water intrusion. Good concreting practice includes use of an appropriate mix design (e.g., minimum 3000 psi concrete), maintaining low water-to-cement ratio (minimize use of water to decrease concrete porosity), and vibrating concrete for good consolidation in forms.

addition, the wall construction should be inspected for penetrations due to voids or other problem areas (such as form ties) and appropriately repaired and sealed.

REFERENCES AND ADDITIONAL RESOURCES:

Basement Water Leakage...Causes, Prevention, and Correction. National Association of Home Builders, Washington DC, 1989

CH2M Hill Engineering Ltd., *Lot Drainage Characteristics Study Natural Storm Events*, Alberta Municipal Affairs, Housing and Consumer Affairs, Canada, ISBN: 0-88654-419-X, February 1994

Controlling Moisture in Homes. National Association of Home Builders, Washington DC, 1981

Crandell, J.H. "Using System-based Design Principles for Affordable, Durable, and Disaster-resistant Housing," *Wood-Frame Housing Durability and Disaster Conference 2004*, USDA Forest Products Laboratory, Madison WI

Durability by Design: A Guide for Residential Builders and Designers, U.S. Department of Housing and Urban Development, Washington DC, 2002, www.huduser.org

Healthy and Affordable Housing: Practical Recommendations for Building, Renovating and Maintaining Housing, U.S. Department of Housing and Urban Development and U.S. Department of Energy, Washington DC, 2004

Steps to Constructing a Moisture-Resistant Foundation, Build a Better Home, APA – The Engineered Wood Association, Tacoma WA, 2001

University of Alberta, Department of Civil Engineering, *Thin Wall Foundation Testing*, Alberta Municipal Affairs, Canada, March 1992

Yost, N. and Lstiburek, J. *Basement Insulation Systems*, Building Science Corporation, 2002, www.buildingscience.com

2.4.3 Basement Wall Insulating & Finishing

OBJECTIVE: Basement wall finishes are exposed to a unique environment in terms of moisture concerns. The foremost concern is exterior moisture, which is addressed in Section 2.4.2. This section focuses on the use of insulation, vapor barriers, and air leakage sealing practices to construct finished basement areas.

PRECAUTIONS: The approaches for insulating and finishing basement spaces will vary depending on whether you're dealing with new or existing construction, and whether a basement is being only insulated (but not finished). Existing basements obviously have limited options for using exterior foundation insulation. And some interior insulation approaches using foam that offer good moisture performance, also require covering with a fire-resistant layer like gypsum, so they're a good approach for a finished basement but not effective for only insulating an unfinished area.

Strategies on basement finishing differ among various experts in the industry. Any successful basement finish design requires that exterior waterproofing (Section 2.4.2), relative humidity control in the basement (Section 2.5.4), and air sealing (Section 2.5.5) are properly addressed.

BEST PRACTICE:

Because this guide is intended to be useful for both new and existing construction, the approach shown for basement insulating/finishing concentrates on *interior* insulation systems. Note that *exterior* insulation strategies using foam insulation panels on the outside of the foundation wall are also a viable option for new construction, providing

2.4.3 Basement Wall Insulating & Finishing

a moisture-tolerant insulation layer on the outside of the wall. This insulation layer that moderates the temperature of the inside wall surface and can also be integrated with exterior water- or damp-proofing. However, this approach requires shifting the house structure outward such that the sill plate overlaps the upper edge of the foundation insulation, protecting exterior insulation during construction, and providing long-term protection for the exposed insulation. Further details on the exterior insulating approach can be found in the References section.

For interior insulation systems, the approaches offered below are illustrated in Figure 25. While this type of basement finish construction may be more commonly found in commercial applications for below-ground space, the concept is relatively new to residential construction as a best practice. *Therefore this strategy is included here primarily for consideration where traditional practices (e.g., use of a warm-in-winter vapor retarder on the inside of the finish wall system) have resulted in moisture problems and a wall system that dries toward the interior is desired. This technique, as well as traditional basement finish practices, is not intended to compensate for inadequate waterproofing, foundation drainage, indoor relative humidity control, or air leakage control.*

Design Basement Insulation and Finishes to Dry to the Interior

Low permeability and continuous vapor retarders, like polyethylene sheeting or vinyl wall paper, on the interior side of basement finishes should be avoided because they will tend to trap moisture vapor moving through the foundation wall and slow the drying process for new foundations. Therefore, unfaced fiberglass batt insulation and permeable paint finishes on gypsum wall

board should be preferred on basement finished wall assemblies. Other proprietary basement finish systems, using products such as rigid fiberglass insulating boards, have also performed well in testing and use. However, use of certified installers may be required by the manufacturer.

Use Semi-Permeable Rigid Foam Insulation between the Foundation Wall and Finish Wall Assembly

The use of rigid foam creates a buffer of moisture-resistant material between the finish wall materials and the basement foundation wall. Because below grade portions of the foundation wall must be able to dry to the interior, semi-permeable rigid foam insulating sheathing products (e.g., EPS or XPS) should be used. Since product permeability levels will vary by manufacturer, check exact product specifications to ensure that the perm rating for the required thickness is greater than 1 perm.

Using Interior Foam Insulation in Unfinished Basements

The use of semi-permeable rigid foam insulation on the inside of basement foundation walls is a good strategy for a moisture-resistant finished basement. However, fire and smoke characteristics of this type of insulation will require that it be covered with a fire resistant layer like gypsum. This works fine when the basement is being finished.

But if a basement will only be insulated and not finished, a fire-rated foam panel or similar fire-rated covering needs to be used. Because the above-grade portions of the basement wall can dry to the outside, fire-rated insulation on these surfaces can be impermeable (e.g. it can have a foil facing). But insulating approaches that restrict the drying potential of *below-grade* portions of the foundation wall towards the inside should be avoided. The References section provides further resources on this type of design.

ILLUSTRATED BEST PRACTICE:

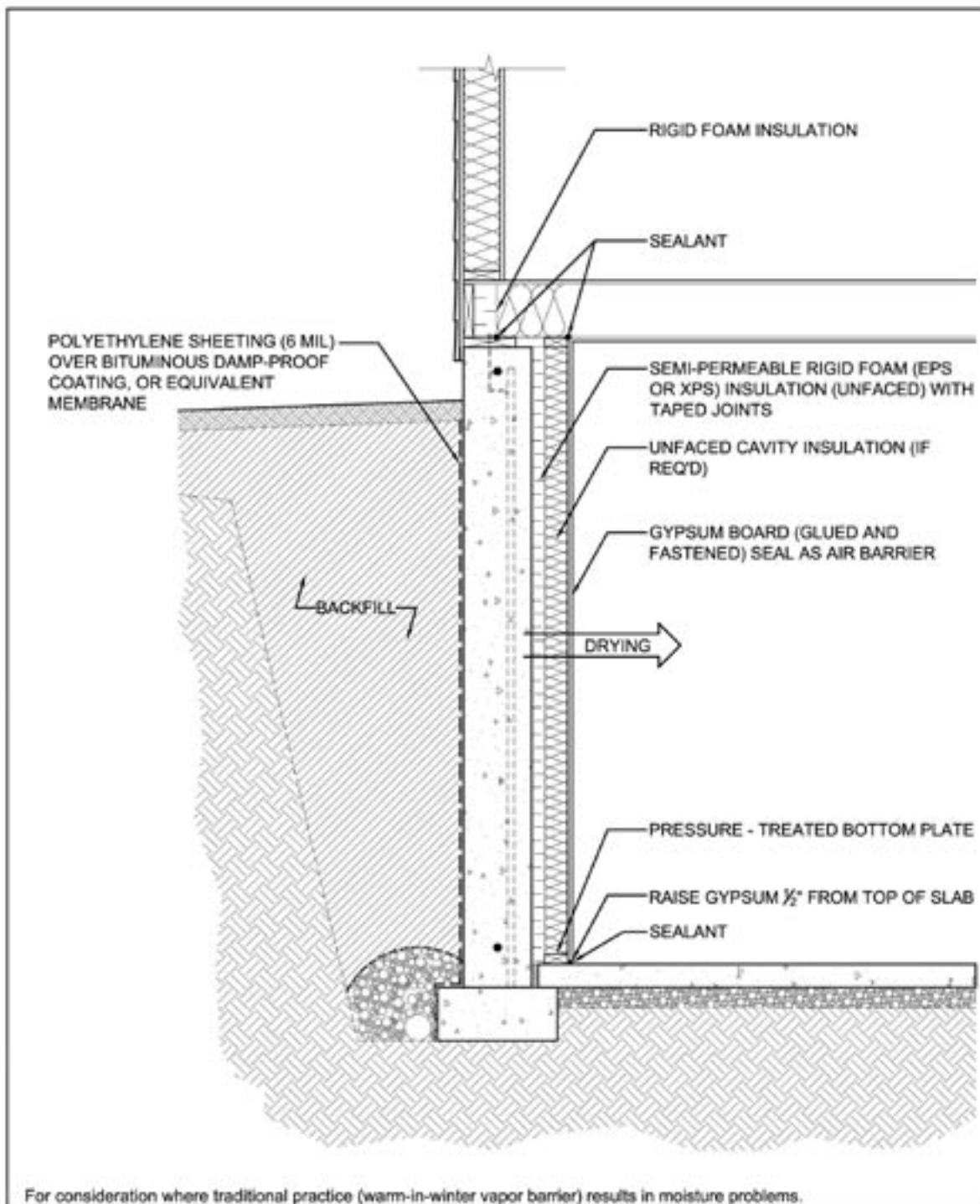

Figure 25 - Moisture-Resistant Basement Wall Finishes

2.4.4 Slab on Grade Construction

Joints in the foam sheathings should be taped and sealed. If additional insulation is required or desired, a frame wall may be built and cavity insulation used as shown in Figure 25.

Prevent Warm Humid Indoor Basement Air from Leaking Through the Finish

To prevent humid, interior basement air from leaking into the finished wall assembly and condensing, the interior side of the assembly should be sealed against air leakage. The ideal approach uses the gypsum wall board as an air barrier and requires sealing any penetrations through or leaks around the panels. Air sealing of ceiling penetrations in the basement should also be addressed. Section 2.5.4 discusses this approach, called the Airtight Drywall Approach. Also, joints in the foam insulation should be taped and sealed.

Separate Wall Finishes from the Basement Floor Slab

Gypsum wall board, wood trim, and wood framing will wick moisture from the slab. In addition, the slab will tend to cool materials it is in contact with (creating higher surface humidity levels that may support mold growth). Therefore, finishes and baseboard trim should be held up about ½-inch from the slab surface. This gap should be sealed with caulk or sealant to prevent air leakage from indoors into the wall assembly. In addition, a thin foam plastic sill sealer may be used underneath the finished wall bottom plate for added moisture protection.

REFERENCES AND ADDITIONAL RESOURCES:

“Basement Walls That Dry Quickly”, *Research Highlights*, Technical Series 99-109, Canada Mortgage and Housing Corporation, Ottawa, Ontario, Canada, www.cmhc-schl.gc.ca

Healthy and Affordable Housing: Practical Recommendations for Building, Renovating and Maintaining Housing, U.S. Department of Housing and Urban Development and U.S. Department of Energy, Washington, DC, 2004

Owens Corning Basement Insulation System, Experimental Evaluation Project, www.buildingfoundation.umn.edu/OCBasementSystem/default.htm

Yost, N. and Lstiburek, J. “Basement Insulation Systems”, Building Science Corporation, www.buildingscience.com

2.4.4 Slab on Grade Construction

OBJECTIVE: In this section, slab on grade (thickened edge or monolithic slab) foundation construction is addressed. Given their similarity, concrete or masonry stem wall foundations with an independent above-grade slab floor are also addressed. The moisture-resistant best practices featured in this section are summarized in Figure 26. They are relatively simple in comparison to the requirements for basement construction; however, many of the same principles apply. Slabs below the outside ground level, as with partial or full-basement construction, should be built in accordance with the basement foundation recommendations in Section 2.4.2. Moisture-resistant best practices for concrete floor finishes are addressed in Section 2.4.5.

PRECAUTIONS: Slab on grade construction is most suitable for relatively flat sites. However, for sites that are low-lying and flat, surface water ponding may occur seasonally or with rainfall events. On such sites, recommendations given in Section 2.4.1 should be followed to determine appropriate foundation elevations and site grading. Crawlspace construction is often preferred on such sites. In either case, appropriate moisture-resistant site planning and

foundation practices should be considered a necessity. In mixed and cold climates, careful attention to the slab edge or foundation perimeter insulation should be given to avoid thermal bridges, which can cause cold slab surfaces and condensation.

BEST PRACTICES:

Provide a Mounded Foundation Pad to Achieve 8" Minimum Clearance above Exterior Finish Grade

The elevation of a slab on grade foundation (thickened edge slab or independent slab and stem wall foundation) should be a minimum of 8" above the exterior finish grade. In areas with heavy rainfall, consider clearances greater than 8" or other rain control measure like back-vented cladding with ice and water shield 18" up the wall. The foundation elevation to achieve this effect must be coordinated with the site plan. In particular, ***topsoil must be removed and the foundation pad must be built up with suitable (compactable) structural fill material as required.*** Fills of more than 12" thick are generally required to be engineered - e.g., fill material and compaction method designed and shown on plans as well as verification of compaction achieved on site. As a simple test, the slab foundation pad should be able to support a loaded dump truck with minimal depression from the wheel load (e.g., 1/2" or less). With a properly mounded slab and site grading (refer to Section 2.4.1), surface water will drain away and minimize the moisture load around and beneath the slab.

Use a Sub-Slab Vapor Retarder Directly Below Slabs with a Capillary Break beneath the Vapor Retarder

A vapor barrier (6 mil poly or equal) is generally required below any slab intended as

a floor for habitable space. It should be placed in direct contact with the underside of the concrete slab. The vapor barrier will prevent moisture vapor from adding to the building interior moisture load and also serve as a break to the capillary movement of moisture.

A capillary break layer (3 to 4 inches of clean gravel with no fines) further prevents bulk soil moisture from wicking up to the bottom of the slab. Building codes typically require a capillary layer below the slab, and this should be provided ***under*** the vapor barrier so that water cannot be trapped in a gravel layer between the vapor barrier and the slab. The vapor barrier will help to cure the concrete properly if it is properly damp-cured on the top surface (by preventing exposure to excessive drying conditions), and excessive water in the concrete mix is avoided. If concrete workability is a concern, use a mix designed with additives (e.g., plasticizers) to improve workability without the need for excess water.

Provide for Concrete Slab Crack Control with Reinforcement and Control Joints

Residential building codes generally allow unreinforced concrete slabs of a minimum 3 to 4 inches thick. However, as noted in Section 2.4.2 for basements, concrete will crack as a normal outcome of the curing process. Cracking can be worsened if uneven bearing conditions like un-compacted fill areas exist under the slab.

The use of welded wire fabric reinforcement provides a means of controlling the severity of cracking. While fiber-reinforced concrete may also provide adequate crack control, the introduction of fibers may tend to decrease the workability of wet concrete. Therefore, an appropriate concrete mix design and placement practice should be considered with the use of fiber-reinforced concrete to prevent problems created by use of excessive water

2.4.4 Slab on Grade Construction

ILLUSTRATED BEST PRACTICE:

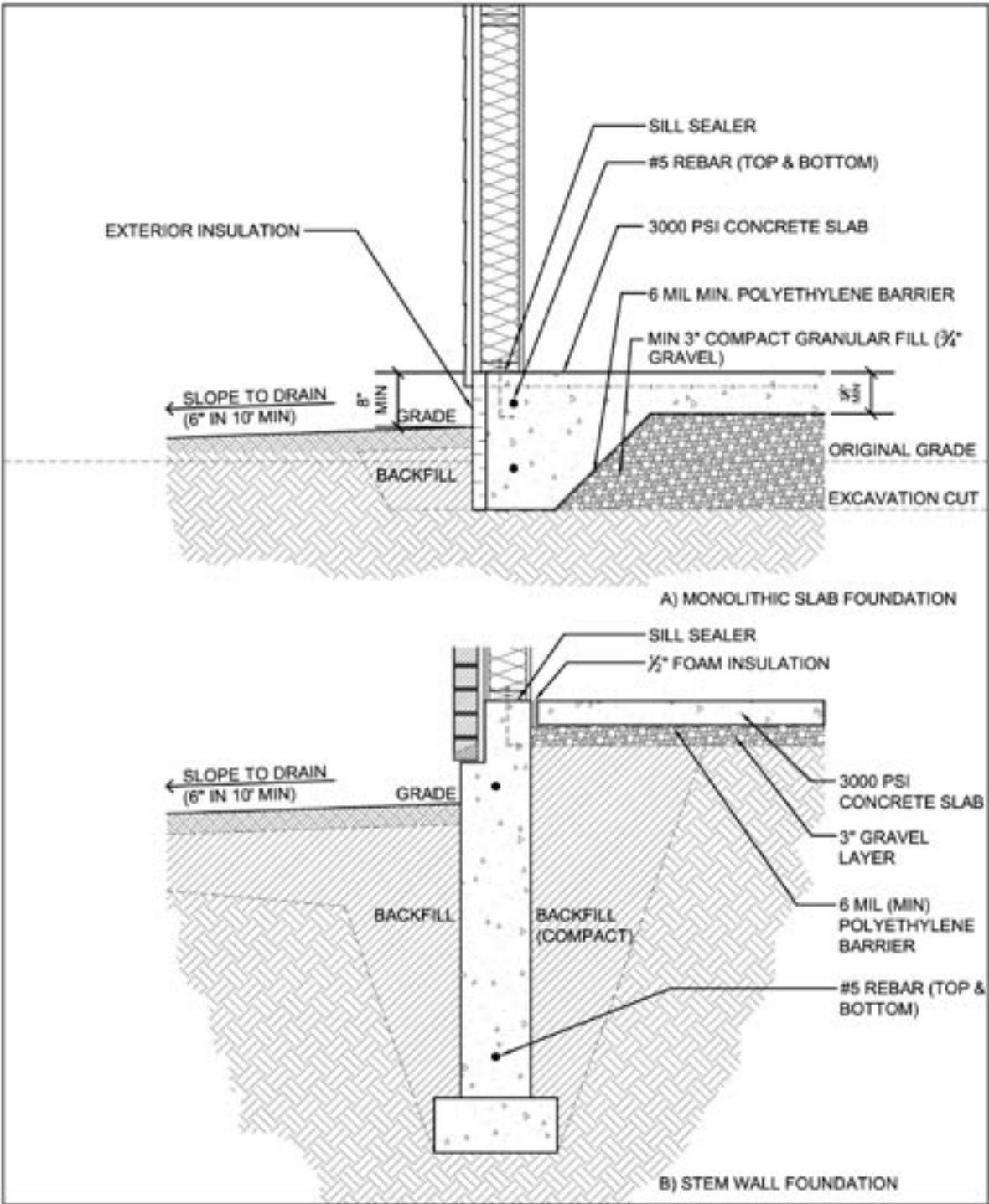

Figure 26 - Slab on Grade Construction

to improve workability. Excessive use of water for workability will tend to allow moisture to more readily penetrate the concrete slab, weaken the concrete, and lead to differential drying issues and cracking. Excessive cracking can allow additional moisture as well as radon gas to penetrate more easily through the slab. Concrete control joints may also be used to control random cracking by creating planned lines of weakness in the slab (shrinkage or curing cracks generally occur in any continuous length of concrete greater than about 12 feet).

Install horizontal rebar as reinforcement to reduce cracking

As with basement foundations and footings (Section 2.4.2), the building code does not always require horizontal reinforcement of the thickened-edge footing of a monolithic slab on grade. The same applies to stem wall and independent slab construction. However, ***this guide recommends a minimum of a continuous #5 rebar located horizontally at the top and bottom of the thickened edge of a monolithic slab or stem wall.*** This allows the thickened slab edge (footing) to act as a moderately reinforced grade beam to reduce cracking from differential settlement. Concrete and masonry stem walls may be reinforced with horizontal reinforcement bars in a manner similar to that recommended for basement walls (see Section 2.4.2). For difficult site soil conditions (e.g., expansive or weak soils), other types of concrete slab foundations may be required or advisable such as mat foundations or post-tensioned slabs.

Apply Slab Foundation Insulation on the Exterior of Slab on Grade Foundations

Building codes allow foundation insulation to be placed in various locations at the perimeter of a slab on grade foundation.

Ideally, the best location for insulation in slab on grade foundations is on the vertical outside face of the foundation. In this location, thermal bridges are minimized, energy efficiency is maximized, and slab surface temperatures are moderated to prevent the risk of condensation during cold weather. If slab on grade insulation is placed in a different location (e.g., on the inside face of the perimeter foundation wall), then care should be taken to create a continuous thermal break between the indoor portions of the slab and the exterior.

When used, exterior foundation insulation must be protected from the elements at additional expense. One way to reduce cost while using exterior slab perimeter insulation is to use a frost protected shallow foundation (see text box). These foundations are most cost-effective in more northern climates where required frost depths are substantially greater than 12 inches and foundation insulation requirements are more stringent.

Frost Protected Shallow Foundations

Frost protected shallow foundation (FPSF) systems offer a design option which allows for shallower footing depths by raising the frost depth around the building through the use of insulation. FPSF systems offer many advantages for slab on grade construction in cold climates, including:

- Reduced construction cost
- Increased energy efficiency
- Improved slab comfort
- Increased slab temperatures to prevent condensation

Ideally, heated slab systems may be used with insulation amounts increased above that minimally required for FPSFs. For guidance on the design and construction of FPSF foundations, refer to the ASCE 32-01 standard listed in the references of this section.

REFERENCES AND ADDITIONAL RESOURCES

Design and Construction of Frost-Protected Shallow Foundations (ASCE Standard 32-01), American Society of Civil Engineers, Reston VA, 2001

Healthy and Affordable Housing: Practical Recommendations for Building, Renovating and Maintaining Housing, U.S. Department of Housing and Urban Development and U.S. Department of Energy, Washington DC, 2004

Steps to Constructing a Moisture-Resistant Foundation, Build a Better Home, APA – The Engineered Wood Association, Tacoma WA, 2001, www.apawood.org

2.4.5 Concrete Slab on Grade Insulation and Finishes

OBJECTIVE: Like basement wall finishes, finishes on concrete floor slabs on grade are exposed to a unique environment due to direct ground contact. This section focuses on appropriate practices for moisture-resistant floor finishes on concrete slabs on grade. These best practices are not intended to compensate for poor site or foundation drainage.

PRECAUTIONS: In newly constructed slabs on grade, it's advisable to delay installation of moisture-sensitive floor finishes for some time after the construction of a slab to allow moisture to dissipate. Simple field test kits are available from wood flooring manufacturers to determine if a slab is dry enough for flooring installation.

BEST PRACTICE:

The best practices featured in this section are highlighted in Figure 27. One method is applicable to conditions where a vapor barrier is applied below the slab, while the second is intended for existing slabs that lack this sub-slab vapor barrier.

Use Moisture Resistant Finishes Where Feasible

Tile, terrazzo, stained decorative concrete, and other moisture resistant finishes are ideal for slab on grade construction from a moisture perspective. These materials are resistant to flooding and other sources of moisture damage, and are typical in southern (hot/humid climates). In such cases, the primary concerns are limiting indoor humidity, providing a sub-slab vapor barrier directly below the concrete slab (e.g., 6-mil polyethylene), and providing a capillary break (e.g., 3 to 4 inch thick clean gravel layer).

Utilize Slab Insulation when using Moisture Sensitive Finishes

Carpet and wood-based floor finishes should not be applied directly to slabs on grade unless the slab or finish surface temperature is raised near room temperature.

Moderated floor temperatures that can accommodate moisture sensitive finishes can be achieved with sub-slab or slab surface insulation as well as perimeter insulation to prevent thermal short-circuits in the slab. Where slab temperatures are chilled by cold outdoor winter conditions or cooled by ground temperatures during the spring and summer, surface condensation or high humidity may result in mold growth or condensation damage.

Add Top-of-Slab Vapor Control before Finishing Existing Slabs without a Sub-Slab Vapor Barrier

Slabs that do not have a moisture vapor barrier underneath often are not suitable for finished flooring in living spaces. This can be the case in both slab on grade foundations and for basement slabs. Newer model building codes always require a moisture vapor barrier (e.g., 6-mil poly) underneath slab on grade floors

2.4.5 Concrete Slab on Grade Insulation and Finishes

serving living spaces. In the event that this requirement is not met in an existing slab on grade or basement slab, water vapor must be controlled from the top of the slab surface.

If a slab shows signs of a pre-existing moisture problem like dampness or condensation, salt deposition, or standing water, that issue should

be addressed before moving ahead with finish flooring. ***Once any pre-existing moisture issues with the slab are addressed, a floor finish assembly that can accommodate a small amount of upward moisture flow can be constructed.*** One viable approach involves the use of a rigid, semi-permeable (>1 perm) insulating sheathing like extruded

ILLUSTRATED BEST PRACTICE:

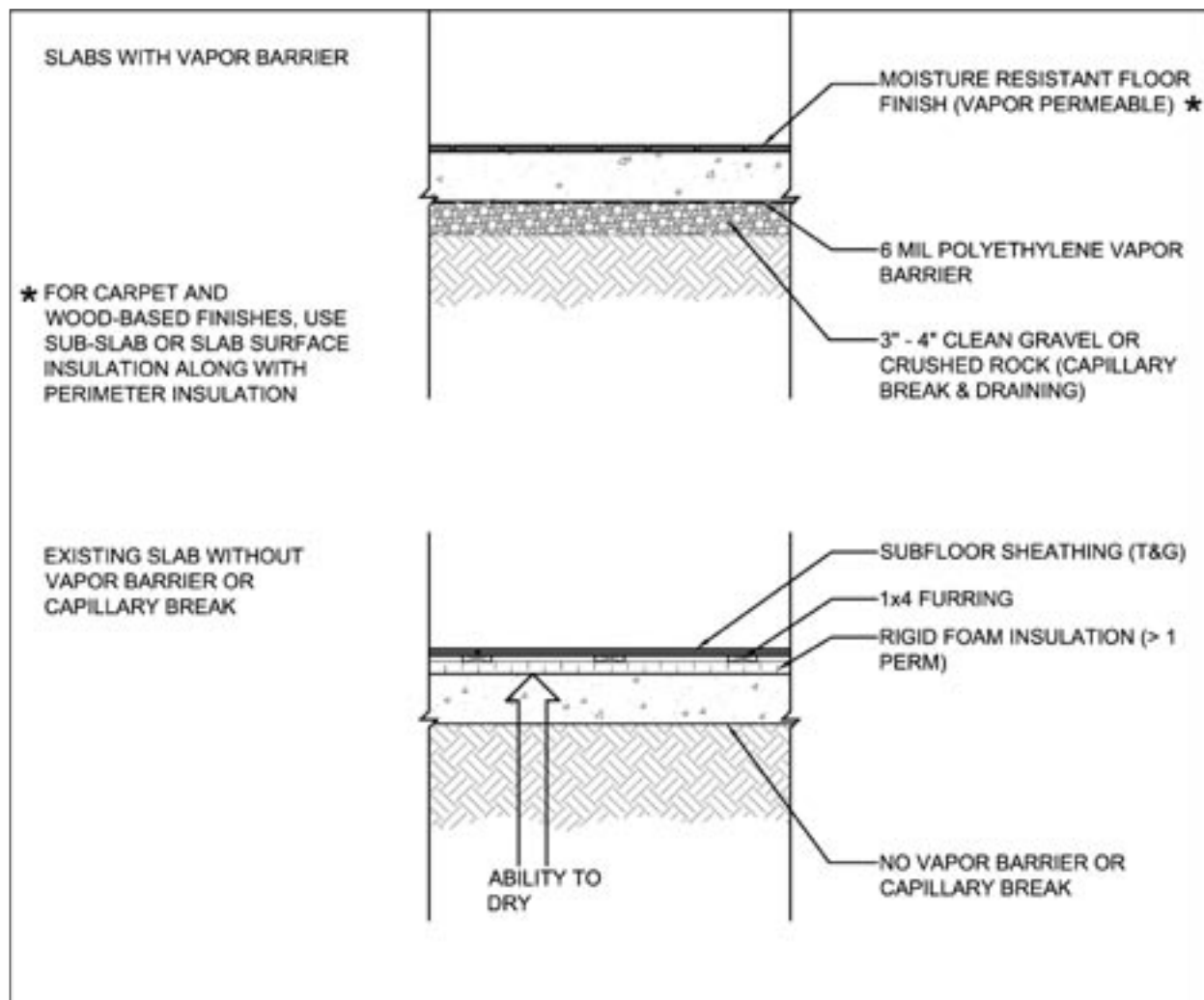

Figure 27 - Moisture Resistant Slab on Grade Floor Finishes and Details

polystyrene on top of the slab, with 12-16" o.c. furring above the foam, followed by a layer of T&G plywood for the subfloor. The finish flooring above the plywood should be a breathable finish, so impermeable materials like vinyl flooring should be avoided. Using this type of assembly, a relatively dry slab without a sub-slab layer of poly can be finished and designed to accommodate a limited amount of moisture which dries upward (see bottom detail in Figure 27).

REFERENCES AND ADDITIONAL RESOURCES:

Healthy and Affordable Housing: Practical Recommendations for Building, Renovating and Maintaining Housing, U. S. Department of Housing and Urban Development and U.S. Department of Energy, Washington DC, 2004

2.4.6 Crawlspace Construction

OBJECTIVES: The top causes of moisture problems in crawlspaces include poor site drainage, lack of a ground vapor barrier, and crawlspace ventilation during humid summer conditions. Crawlspace moisture damage and mold formation can be caused by any one of these issues. Therefore, these issues must be addressed for moisture resistant crawlspace foundations.

PRECAUTIONS: Crawlspace construction should ideally result in an interior crawlspace ground surface that is at or above the exterior finish grade. Extra attention to foundation drainage is required for crawlspaces below the exterior finish grade. Also, venting crawlspaces in humid conditions can result in condensation of warm moist air on cool surfaces in the crawlspace including ductwork and the underside of floor framing. In very humid conditions this can lead to water accumulation, wet insulation, material degradation, and mold.

Use of a Mud Slab

Groundcover laid on crawlspace floors can become damaged or disturbed over time resulting in lost effectiveness. In addition, it is difficult to drain a ground cover that might become wetted on the top surface occasionally, such as from a plumbing leak. As an enhancement that further emulates conventional basement construction, a mud-slab (e.g., 2-inch-thick concrete slab may be placed on top of the groundcover and modestly sloped to drain to a sump pit, if required for low-lying, flood prone, or otherwise wet sites.

BEST PRACTICES:

Provide a Ground Cover for All Crawlspace Foundations

All exposed ground areas in crawlspaces should be covered with a minimum 6 mil layer of polyethylene sheeting. The edges of this sheeting should be overlapped at least 6" and sealed. The polyethylene should also be sealed with tape or adhesive to walls and to all penetrations in the sheeting. This is a simple measure that helps to control ground moisture effectively. If the ground cover initially installed is damaged during the construction process, an additional layer should be added or damaged sections should be patched and sealed.

Provide Foundation Drainage and Damp-Proofing for Crawls below the Exterior Grade

If the crawlspace elevation is below the exterior finish grade, foundation drainage and foundation wall damp-proofing (e.g., bituminous coating on the below-grade exterior face of crawlspace foundation wall) should be provided in similar fashion to that required for basements. Crawlspaces of this type should use the damp-proofing and the exterior drainage system noted in Figure 24 for basements.

Evaluate Vented and Non-Vented Crawlspace Ventilation Strategies

There are essentially two choices for ventilation of crawlspaces. The first follows conventional ventilation practices and the second follows a non-vented crawlspace design strategy. Traditional crawlspace ventilation requirements require a net open vent area of 1:1500 of the crawlspace area to be provided when a crawlspace ground cover (vapor barrier) is present – which should be the case. Vents are placed on at least two opposing sides of the foundation with vents as close as practical to the corners of the foundation. Vents should be placed as high on the foundation walls as possible. This method is established, if not entrenched, and the reader is referred to the locally-applicable building code for additional information.

As a second option, *there is mounting evidence as well as recent model building code recognition that non-vented crawlspaces are an acceptable method of crawlspace foundation construction. The method is particularly suitable for hot/humid climates, where ventilating with outdoor air actually adds moisture to the crawlspace during much of the year, and should be considered as an option in other climates.* However, there's more to it than simply taking out the vents. The following

Frost-Protected Shallow Foundation Using Non-vented Crawlspace

With a non-vented crawlspace design, a frost-protected shallow foundation strategy provides for energy efficiency as well as cost-effective foundation construction in areas where frost depths exceed about 24". The reader is referred to information on this foundation technology found in Section 2.4.4 on slab foundation construction.

steps must also be followed when building an unvented crawlspace:

- Addressing exterior grading and site drainage (Section 2.4.1)
- Sealing air leakage between outdoors and the crawlspace area (mainly at top of foundation wall and building floor perimeter)
- Insulating the crawlspace perimeter walls – not the floor above (e.g., use of 2" of rigid foam insulation on interior of crawlspace perimeter wall)
- Using a 6 mil polyethylene groundcover in crawlspace with joints lapped and sealed (always recommended in this guide)
- Damp-proofing foundation walls and providing an exterior drainage system when crawlspace ground elevation is lower than outside finish grade
- Providing for some ventilation of the crawlspace with conditioned air

Recent model building codes also require that the non-vented crawlspace be treated as conditioned basement space (e.g., supplied with conditioned air along with a return-air transfer grill placed in the floor above the crawlspace). Alternatively, the crawlspace must be mechanically ventilated or designed as an under-floor space plenum for distribution of conditioned air. While non-vented crawlspace designs without these features have performed well, builders should check with local code requirements when designing a non-vented crawlspace.

REFERENCES AND ADDITIONAL RESOURCES:

Closed Crawl Spaces: An Introduction to Design, Construction, and Performance, Advanced Energy Corporation, 2005, www.advancedenergy.org

Crawlspace Ventilation and Moisture Control in British Columbia Houses, Research and Development Highlights, Technical Series 90-231, Canada Mortgage and Housing Corporation, Ottawa, Canada, www.cmhc-schl.gc.ca

Davis, B. and Warren, B. "Crawlspace Ventilation and Moisture Control Research", *Wood Design Focus*, Vol. 13, No. 2, Forest Products Society, Madison WI, 2003

Durability by Design: A Guide for Residential Builders and Designers, U.S. Department of Housing and Urban Development, Washington DC, 2002. www.huduser.org

Healthy and Affordable Housing: Practical Recommendations for Building, Renovating and Maintaining Housing, U. S. Department of Housing and Urban Development and U.S. Department of Energy, Washington DC, 2004

International Residential Code (IRC), International Code Council, Inc., Falls Church VA, 2003, www.iccsafe.org

Rose, W. "Crawl Spaces: Regulations, Research and Results." *Bugs, Mold and Rot II Proceedings*, BETEC, November 1993

Supplement to the International Codes, International Code Council, Inc., Falls Church VA, 2004

Yost, N., "The Case for Conditioned, Unvented Crawl Spaces", *Building Safety Journal*, Vol. 1, No. 3, International Code Council, Inc., Birmingham AL, May 2003

2.4.7 Ground Clearances for Wood Protection

OBJECTIVE: Decay of common wood framing materials can begin when moisture content of untreated wood exceeds 20%. In foundation and building applications, these conditions should be avoided by adherence to minimum ground clearances and detailing requirements.

PRECAUTIONS: The ground clearances in this section are considered as *minimums* that have worked reasonably well in typical climates. In climates with frequent rainfall or sites with continuously moist ground conditions, greater clearances should be considered. In addition, capillary breaks are important, particularly when clearances are at minimums. Capillary breaks help to protect wood from wicking up moisture in the ground around a foundation, and may take the form of materials like metal flashing, tarred-felt paper, sill-sealer foam stripping, or polyethylene. When wood has direct ground contact or clearances are less than required, then preservative-treated wood or other moisture-resistant materials should be used (see Section 2.4.8).

BEST PRACTICE:

Maintain Minimum 8" Clearances to Protect Wood from Ground Moisture

One of the oldest and most trustworthy practices to prevent wood and other moisture sensitive materials from decay is separation from a constant uptake of moisture from the ground. Decay conditions can occur when wood is in direct ground contact or when moisture wicks through other materials such as concrete or masonry. Some well known details for separation of wood from ground moisture are shown in Figure 28. Most building codes require a minimum of 6" clearance between untreated wood and the exterior grade, and some codes allow a 2" reduction in this clearance if brick veneer separates internal wood materials from the exterior grade. ***A minimum of 8" clearance between untreated wood and the exterior ground level is recommended in this guide.*** In other conditions shown in Figure 28, ground clearance recommendations vary (e.g., floor beams in crawlspaces are required to have a minimum 12" clearance to interior grade as much for reason of access as for moisture protection).

2.4.7 Ground Clearances for Wood Protection

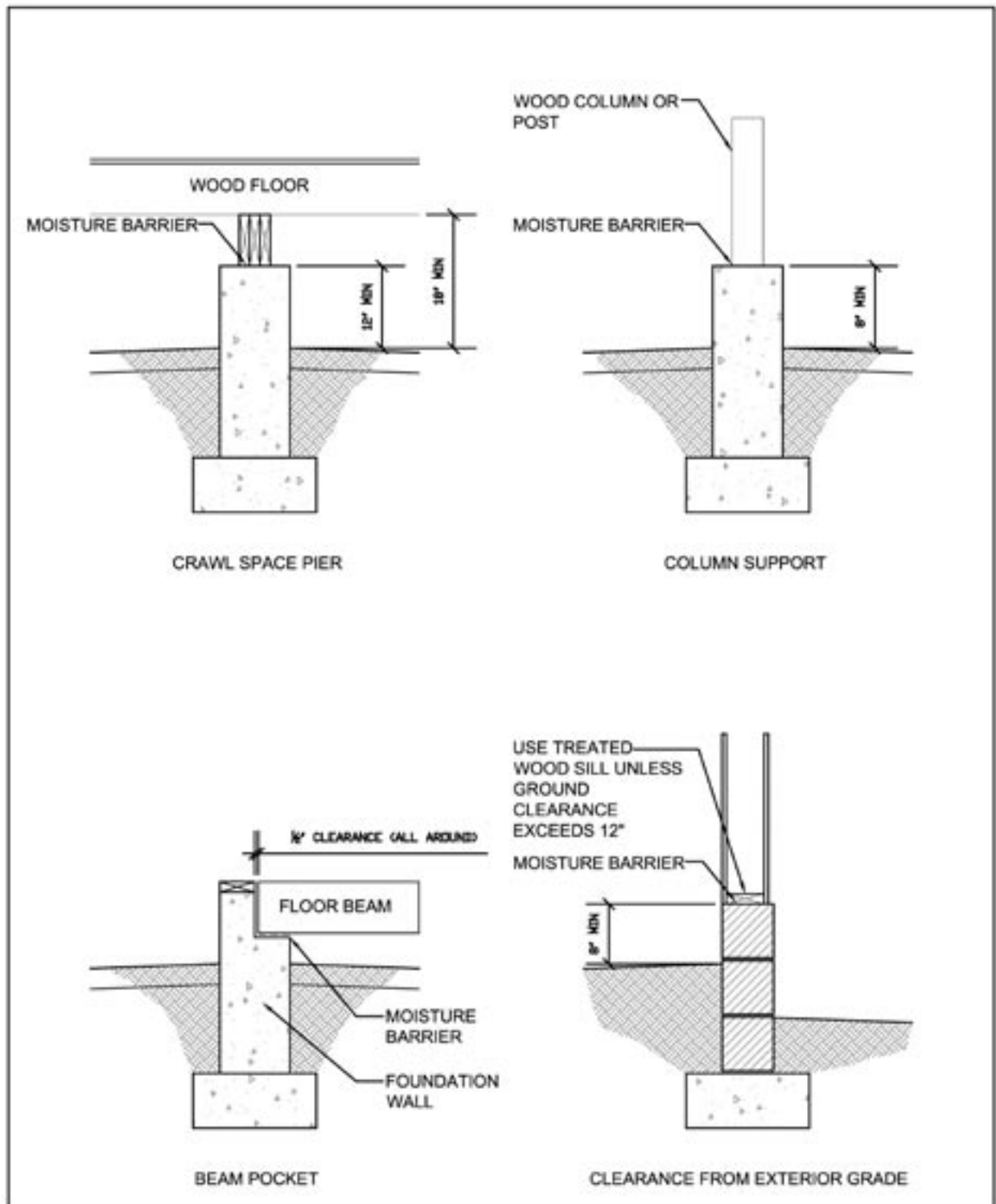

Figure 28 - Details to Separate Wood from Ground Moisture

REFERENCES AND ADDITIONAL RESOURCES:

Durability by Design: A Guide for Residential Builders and Designers, U.S. Department of Housing and Urban Development, Washington DC, 2002, www.huduser.org

Steps to Constructing a Moisture-Resistant Foundation, Build a Better Home®, Form No. A520, APA—The Engineered Wood Association, Tacoma WA, 2001, www.apawood.org

2.4.8 Preservative Treatments for Wood Protection

OBJECTIVE: There are often situations where wood cannot be adequately separated from ground moisture or protected from exterior moisture sources. In these situations, either naturally decay-resistant wood or preservative-treated wood must be used. In some cases, wood alternatives may be considered, such as plastic porch posts with metal pipe inserts, plastic decking, concrete posts or piers, or plastic lumber composites. The focus of this section is on proper specification and use of preservative-treated wood to ensure moisture (decay) resistance and durable performance. The best practice recommendations in this section are based on *Southern Pine Council* and *American Wood Preservers Association (AWPA)* standards and recommendations (see References).

PRECAUTIONS: In recent years, changes have occurred in the availability of certain wood preservative treatment chemicals for use on residential projects. Therefore, it is important to understand how these changes affect treatment requirements for various types of wood and applications. In particular, the use of CCA (chromated copper arsenate) has been discontinued as a wood treatment except in certain commercial or agricultural applications (e.g., pile foundations, fence posts, etc.).

Use of Foam Sill Sealer Strip on Foundation Sill and Wall Sole Plates

Wood sill plates or wall sole plates on exterior foundation walls can be exposed to moisture due to wicking through concrete (capillary action) or due to condensation. Using a foam sill sealer product (e.g., 1/8" thick closed-cell foam strip) creates a capillary break as well as a modest thermal break. It also prevents a common air-leakage path that can contribute to moisture vapor transport and condensation.

However, there are exceptions: for example, CCA treated lumber and plywood is still available for use in permanent wood foundations (PWF) in residential as well as commercial and agricultural applications. For durable and moisture-resistant construction of PWFs, refer to the *Permanent Wood Foundations Design and Construction Guide* listed under References and Additional Resources. But for most residential applications, newer forms of treatment are the only choices.

It's important to realize that many of the newer lumber preservative treatments may increase the corrosion rate of galvanized fasteners by a factor of 2 or 3 under standardized test conditions. Therefore, in cases of exposure to moisture (e.g., decks, porches, and balconies), it is recommended that stainless steel fastener and connector materials be considered. At a minimum, hot-dipped galvanization or a G120 galvanic coating should be specified for steel fasteners and cold-formed steel connectors. A G120 coating provides at least twice the galvanic coating commonly used for framing connectors in residential construction. Connectors *within* the building envelope that are in contact with newer lumber preservative treatments are generally exempted (e.g., 1/2" diameter sill anchor bolts).

2.4.8 Preservative Treatments for Wood Protection

BEST PRACTICE:

This best practice provides a 3-step process for matching the treatment level of preserved wood to the type of service and exposure involved in the application.

STEP 1: DETERMINE THE USE CATEGORY FOR TREATED WOOD APPLICATION

There are five basic use categories for the specification of treated wood products that relate to increasing levels of exposure. These use categories are described in Table 10.

Table 10 - Use Categories for Treated Softwood Lumber & Plywood

Use Category	Service Conditions	Typical Applications ^a	Type of Protection
UC1	Dry (interior & above ground)	Interior construction and furnishings	Insects only
UC2	Damp (interior above ground)	Interior Construction	Decay and insects
UC3A	Periodic wetting (above ground)	Coated millwork, siding, and trim	Decay and insects
UC3B	Prolonged wetting (above ground)	<u>Decking, deck joists, fence pickets, sill plates, uncoated millwork</u>	Decay and insects
UC4A	Ground contact or fresh water (non-critical component)	<u>Fence, deck and guardrail posts, crossties & utility poles</u> (low decay areas)	Decay and insects
UC4B	Ground contact or fresh water (critical component)	<u>Permanent wood foundations, building poles, posts, crossties & utility poles</u> (high decay areas)	Decay and insects (high potential)
UC4C	Ground contact or fresh water (critical structural components)	<u>Land and fresh water piling, foundation piling, crossties and utility poles</u> (severe decay areas)	Decay and insects (extreme potential)

Table Note:

a. Table is based on AWPA Standard U1 (see References)

2.4.8 Preservative Treatments for Wood Protection

In general, most residential applications are found in use categories 2 through 4 (UC2 through UC4). An 'A', 'B', or 'C' following the use category further differentiates performance expectations based on risk. Use category 5 (UC5) applies to salt water exposure conditions where significantly greater amounts of treatment are required (e.g., piling, bulkheads, etc.) and is not shown. The use category for fire resistance is separately identified as UCFA or UCFB. Because UCFB relates to conditions of exposure to moisture, UCFA treated lumber and plywood is more common in residential construction where fire resistance may be required by code (e.g., roof sheathing on townhouse or apartment buildings).

STEP 2: DETERMINE MINIMUM TREATMENT LEVEL

Based on the use category identified in STEP 1, determine an appropriate type and level of treatment from Table 11. **IMPORTANT:** The following treatment recommendations are for Southern Pine wood species. For other wood species, different types or levels of treatment may be required. Refer to local supplier and AWPA treatment standards for appropriate guidance. Creosote and oil-borne preservatives are not included in these recommendations and are not generally used in residential applications.

Table 11 - Levels of Preservative Treatment for Southern Pine

Product and Application	Use Category	Waterborne Preservatives (lbs. per cubic foot retention)					
		CCA	ACQ Type C or D	ACQ Type B	CA Type B	CA Type A	ACZA
Lumber, Timbers & Plywood							
Above Ground	UC1-3	0.25	0.25	NA	0.10	0.20	0.25
Soil/Freshwater	UC4A	0.40	0.40	NA	0.21	0.41	0.40
Wood Foundation	UC4B	0.60	0.60	0.60	0.31	0.61	0.60
Piles							
Land/Freshwater	UC4C	0.80	NR	NR	NR	NR	0.80
Poles							
Building Construction	UC4B	0.60	NR	NR	NR	NR	0.60
Posts							
Building Construction	UC4B	0.60	0.60	NA	0.31	0.61	0.60
Fence (round)	UC4A	0.40	0.40	0.40	0.21	0.41	0.40
Fence (sawn)	UC4A	0.40	0.40	NA	0.21	0.41	0.40

Table Note:

a. Table is based on Southern Pine Council recommendations (see References). Preservative treatment recommendations will vary for other species of wood.

STEP 3 – STORE AND INSTALL TREATED WOOD PROPERLY

Check treated lumber certificates or labels to ensure that the appropriate level of treatment has been delivered. Treated lumber should be stored on the jobsite following the same procedures for untreated wood.

Recommended practices include:

- supporting stacks on adequate blocking
- protecting from rain with a tarp
- allowing for ventilation of stacks

In some applications, treated lumber may be painted or coated and must be adequately dried; KDAT (kiln dried after treatment) may be specified to ensure lumber is delivered in a dry condition. However, improper storage prior to or after delivery and high humidity may allow even KDAT lumber to become too moist for proper coating. Therefore, when treated lumber is to be coated, a moisture meter should be used to ensure that a sufficiently low moisture content is achieved (refer to coating manufacturer recommendations). Finally, when installing treated lumber, cuts should be field treated (brush on or dip into treatment) and uncut ends should be placed in the more exposed condition (e.g., end of post in ground). Field treatment of cuts and holes is necessary (and often code-required) because pressure treatment does not usually penetrate the entire thickness of wood members.

REFERENCES AND ADDITIONAL RESOURCES:

AWPA U1, *Use Category System for Treated Wood*, American Wood Preservers Association, Granbury TX, 2002, www.awpa.com

Permanent Wood Foundations Design & Construction Guide, Southern Pine Council, Southern Forest Products Association, Kenner LA, 2000, www.southernpine.com

Pressure-Treated Southern Pine, Southern Pine Council, Southern Forest Products Association, Kenner LA, 2004, www.southernpine.com

2.4.9 Alternative Foundation Construction Methods

Other types of foundation wall construction methods and materials that are less frequently used in the United States include:

- Permanent Wood Foundations
- Insulating Concrete Forms
- Pre-cast Concrete Foundations
- Elevated Foundations in Flood-prone Areas

These systems are not specifically addressed in this guide except to mention that there are important foundation moisture management practices that may be required. The user should carefully consider manufacturer and industry recommended practices in addition to any relevant minimum building code requirements. With proper consideration and installation, these systems have provided dry and serviceable foundation systems.

2.5 Best Practices for Moisture Vapor Control

2.5.1 General

This section focuses on best practices to control moisture vapor and the condensation and damp conditions it can cause in a house. The terms “moisture vapor” and “water vapor” are used interchangeably.

In sections 2.2 through 2.4, best practices focused on preventing bulk water intrusion through roof, wall, and foundation assemblies. Without bulk water intrusion in check, efforts to control moisture *vapor* may be partially successful at best and counter-productive at worst. For example, using vapor retarders and sealing air leakage pathways can be good practices for managing moisture vapor in a wall, but if rainwater is leaking into this wall then these steps could actually worsen the problem by reducing the wall’s ability to dry out. The point is – ***practices for managing vapor may also affect bulk water management and vice-versa – so it’s important to consider both issues.***

2.5.2 Climate Considerations

In the northern U.S., moisture vapor problems are driven primarily by indoor relative humidity (RH) levels combined with low outdoor temperatures during the winter. In the southern U.S. (especially the Southeast), the problem is largely driven by high outdoor humidity and low indoor temperatures during summer months. Mixed climates are exposed to both conditions and can experience both types of problems. Therefore, many of the best practice recommendations in this section vary in accordance with climate. The same is true of the underlying building code requirements.

Unfortunately, there is no definitive and widely accepted climate map that addresses all climate factors that contribute to moisture vapor problems. There are perhaps too many variables in climate and construction practices to treat the issue without significant use of experience and judgment at this time. Various climate maps and criteria have been applied in building codes in the past, and more recent building code changes continue to demonstrate a lack of stable agreement among experts. It is for this reason that accepted practices for moisture vapor control often vary based on local experience and differences of opinion.

This guide attempts to avoid the problem as described above by using three “tried and true” climate maps for the purpose of guiding moisture vapor best practice decisions. These maps are shown in Figures 29, 30, and 31. They are not intended to imply any unique degree of certainty in associating climate conditions with appropriate practices for moisture vapor control. They do, however, provide correct *trends* in correlating vapor control practices to climate that should be considered when implementing an appropriate local practice.

Heating degree days (HDD) as shown in Figure 29 are the primary basis for defining climate zones used in building codes for energy efficiency and moisture vapor control. For the purpose of discussion of concepts and best practices in this guide, the following climate regions are approximated based on heating degree days:

Very Cold Climate – HDD of 8,000 or greater

Cold Climate – HDD of 6,000 to 8,000

Mixed Climate – HDD of 2,500 through 6,000

Hot Climate – HDD less than 2,500

2.5.2 Climate Considerations

The Decay Hazard Index of Figure 30 reflects the moistness of the climate in terms of the potential for wood decay. It is indirectly related to frequent high outdoor humidity levels. For the purpose of discussion of concepts and best practices in this guide, the following moisture-related climate zones are approximated based on Decay Index:

Moist/Humid – Decay Index of 70 or greater

Moderately Moist – Decay Index of 35 to 70

Dry Climate – Decay Index less than 35

Finally, the Condensation Zone Map (Figure 31) has been used in the past to direct when

vapor retarders are to be placed on the warm-in-winter side of thermal insulation comprising the thermal envelope of a building. In recent years, either a hot/humid climate criteria or a heating degree day zone may have been used for this purpose. As a result, recommendations for the use of vapor retarders on the warm-in-winter side of above-grade thermal envelopes may vary by as much as several hundred miles (to the north or south). The important observation is the trend in regard to use of vapor retarders with respect to climate (discussed in 2.5.6), and that not any one criteria is necessarily an exact directive (except of course for local building codes where an inexact directive may become a very exact law).

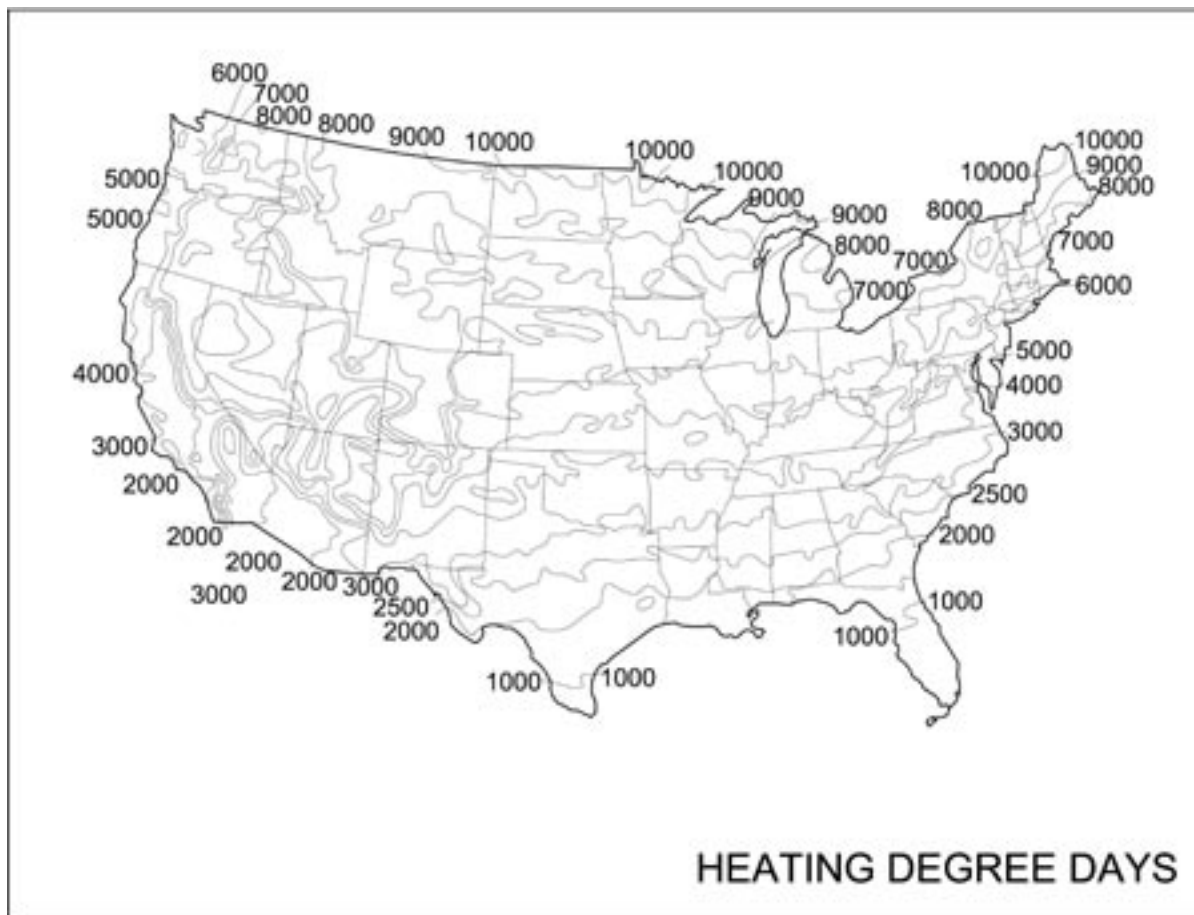

Figure 29 – Heating Degree Day Map

(Based on Annual Heating Degree Days map, 1961-1990 from National Climatic Data Center)

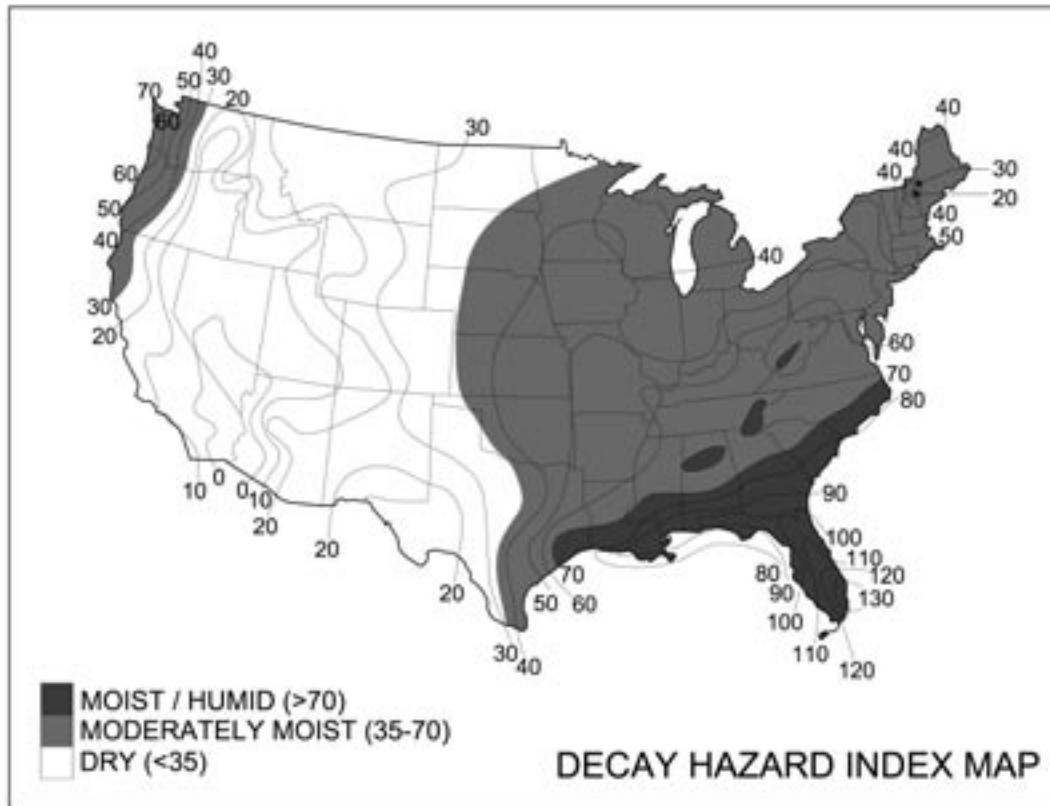

Figure 30 - Decay Hazard Index Map

(Based on A Climate Index for Estimating Potential for Decay in Wood Structures Above Ground, Scheffer, 1971)

2.5.3 Overview of Moisture Vapor Problems

Moisture problems related to water vapor can be confusing because they're caused by several types of moisture sources and can result from different types of dynamics in a house. Also, seemingly unrelated decisions that you make for one building system – like how to lay out the HVAC system– are not at all independent and will affect the migration of water vapor in a house.

Water vapor problems typically involve multiple factors too. Removing one or

more of these factors will often correct or prevent a problem from occurring, even in complicated scenarios where several factors are involved. *Many water vapor problems can be prevented by addressing a few fundamental issues in houses – indoor humidity, air leakage, and vapor retarder location. Addressing these issues with some basic best practices is the focus of the following sections.* A selection of more complex design issues related to water vapor control – some of which are controversial issues currently without a clear consensus best practice - are also discussed briefly and referenced to further resources.

2.5.3 Overview of Moisture Vapor Problems

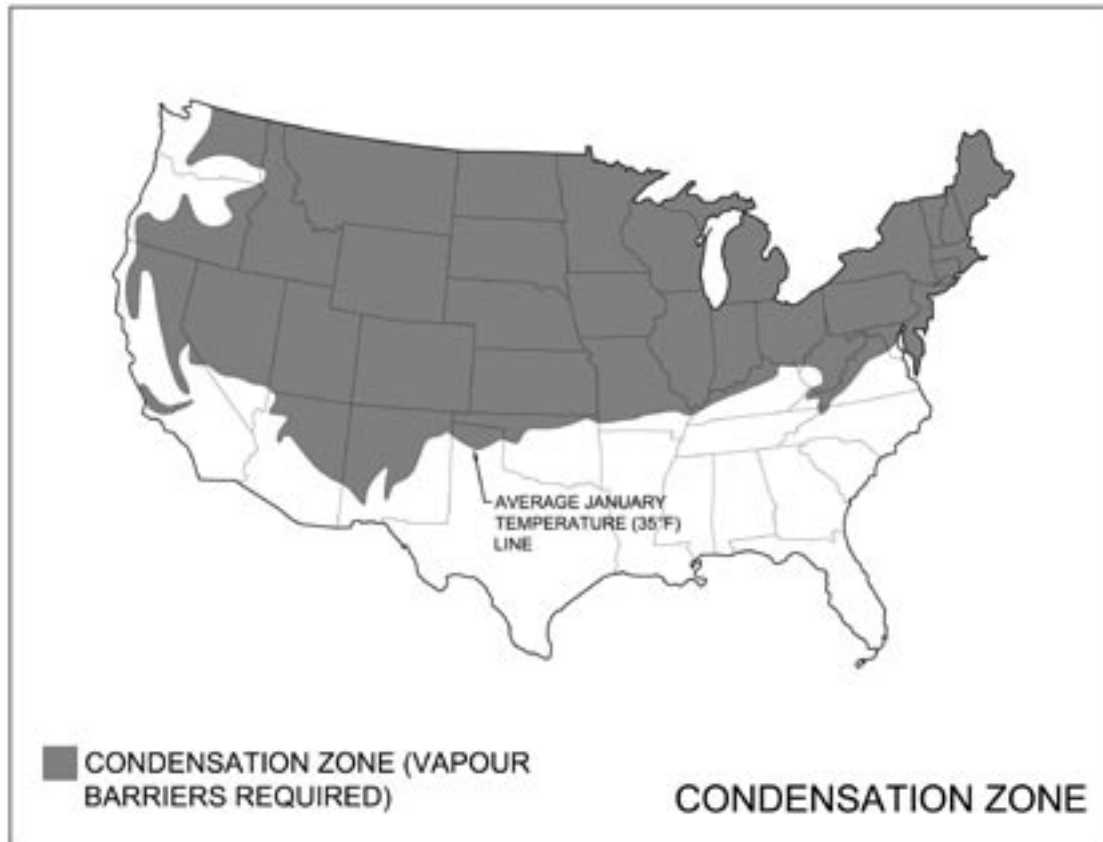

Figure 31 - Condensation Zone Map

(Based on Prevention and Control of Decay in Homes, U.S. HUD 1978)

Defining the Water Vapor Permeance of Materials

Discussions of water vapor, vapor migration, and vapor retarders require clear definitions. This guide uses a scale of permeance levels (as measured in perms, or $\text{gr/hr ft}^2 \text{ in. Hg}$) common to building codes and other industry literature.

- vapor retarder is < 1 perm
- vapor impermeable < 0.1 perms (also called a vapor barrier)
- vapor semi-impermeable $0.1 - 1.0$ perms
- vapor semi-permeable $1 - 10$ perms
- vapor permeable > 10 perms

The permeance of materials can be measured with ASTM E-96 using the “dry-cup” method, in which the test sample is evaluated with 0% RH on one side and 50% RH on the other. It’s also important to realize that many materials exhibit different permeance behavior depending on the local humidity levels, which can mean significantly higher perm levels at higher RH. For example, 15 pound asphalt felt has a rating of ~ 1 perm using the dry-cup method and 5.6 perms using the wet-cup method (which tests a sample at 50-100% RH). Similarly, $\frac{1}{2}$ ” OSB varies with humidity from 0.06 perm (10% RH) to 1.2 (50% RH) to nearly 4 perms (90% RH). The 2005 ASHRAE Fundamentals Handbook contains permeance data for a range of construction materials, and manufacturers can also provide exact data for specific products.

2.5.4 Controlling Indoor Humidity

OBJECTIVES: High indoor humidity (>40% in the winter or > 60% in the summer as a general range) is a central cause of many vapor-related moisture problems in homes. The following best practices will help to control indoor relative humidity (RH) levels in homes. Because many of these practices are related to other building systems, several recommendations include references to other sections of this guide. And while implementing every single one of these measures will provide multiple layers of RH control, using a somewhat smaller selection of these practices should provide good RH control in most cases.

PRECAUTIONS: From a moisture perspective, very low indoor relative humidity levels are helpful to control condensation and related problems. But other important factors that actually require some minimum level of indoor RH to be maintained must also be considered. These include a minimum humidity level to keep occupants comfortable (~25%), minimum humidity to keep wood finishes and furniture from drying out, and homeowners with special needs for higher indoor humidity levels.

BEST PRACTICES:

Provide for Increased Ventilation

When interior RH levels are a concern, provide for increased whole-house and spot ventilation with dry outdoor air and add ventilation controls that automate spot exhaust. High RH levels might be a concern based on local experience and climate, high expected occupancy loads, unusual occupant habits, or especially tight construction. Providing for increased ventilation means selecting higher capacity fans for whole-house or local ventilation devices. Also, when specifying fan equipment, keep in mind that

as-built installations often achieve as little as one-half of the rated fan flow. This can be addressed by specifying higher capacity fans and keeping ducts runs short and direct.

Fan selections should also account for the sound rating of the fan, with quiet, low sone fans (< 1.5 sone) being a good choice for units installed in living spaces like a bath exhaust fan. Controls that can help enhance ventilation include humidistats (which run based on a humidity setting), combination light/fan switches (which turn on the fan whenever the light is on), timer switches (which run a set time), or even combination light/fan switches with a programmable delay control for the fan (which offer the benefits of both combination switches *and* timers). Intermittent operation of spot exhaust fans is recommended in climates dominated by air-conditioning. Another option is continuous fan operation at a low level with local switches that can boost the fan speed temporarily. ***It is critical to note that in humid regions, the addition of moist outdoor air without any treatment of this new moisture load will actually add moisture to the house instead of helping to control indoor RH. Heating, cooling, and ventilation systems in such climates should be specified and operated to accommodate additional moisture loads resulting from ventilation.***

Provide Supplemental Dehumidification Capacity beyond Central A/C

Supplemental dehumidification systems address indoor RH by managing both built-in moisture in new houses – like the water that dissipates from a new concrete basement - and ongoing moisture loads in existing homes. ***Controlling ongoing moisture loads is especially important in areas with humid shoulder seasons, when the A/C system will not operate for cooling but indoor humidity still must be removed.*** Supplemental dehumidification equipment options are discussed in Section 2.5.7.

Protect Building Materials from Exposure during Storage and Construction

Moisture-sensitive building materials should be protected from exposure to excessive moisture while being stored on site and also prior to closing in the building. ***Wood products such as structural panels and framing lumber should be kept under roof whenever possible. If such components cannot be kept under roof on site, at a minimum they should be protected and not stored in direct contact with the ground.*** Components such as wood structural panels should be elevated off the ground with a platform supported by at least three 4x4's (one in the center of the platform and the other two 12" to 16" from each end). The platform should also be covered at the base with a plastic sheet to block the migration of ground moisture up into the stack of panels. Stored panels on the platform should be covered on the top and sides with a plastic sheet that shields the panels from rain, but is also loose enough to allow some air circulation around the stack.

In applications where moisture sensitive materials must be exposed to the weather for a period of time after their installation (before the building is closed in), consider means to protect these materials or specify alternative materials that can better withstand moisture. A common example of this is the firewall assembly in townhouse construction, which is often comprised of multiple layers of fire-rated gypsum wall board between adjacent units. Because these materials are left exposed for some time during construction, alternative materials such as moisture resistant gypsum should be considered in these types of applications. Drywall manufacturers now produce such products for these types of applications.

Finally, shipments of lumber and other framing materials should be inspected upon delivery to confirm that they meet any builder-supplier agreements for moisture and/or mold. Agreements of this type can be helpful in heading off disputes about what to do with product shipments that have perceived mold or moisture issues. In agreements of this type, builders typically have a limited period of time (e.g., 24 hours) in which to inspect lumber shipments. Lumber products with proprietary mold-inhibiting coatings can also be specified to reduce the risk of mold formation on lumber during and after construction.

Ensure that Building Materials are Suitably Dry Prior to Close-In

Building assemblies like exterior walls that become severely wetted during the construction process should be tested to confirm that they're suitably dry prior to close-in. This is especially true if the wall assembly includes low permeability materials that will restrict drying of the wall once it's closed in. In addition to avoiding the close-in of wet assemblies that could result in mold or material degradation, checking the moisture content of framing assemblies can also help to protect against excessive wood shrinkage and the damage this causes to interior finishes.

Therefore, a general range of 10-15% moisture content (MC) should be confirmed before closing in assemblies and finishing. And to prevent differential shrinkage of materials and finish damage, it's also recommended that wood be within about 5% of the wood equilibrium moisture content (EMC) conditions for the region. So in areas like the desert southwest where equilibrium moisture content would be roughly 5-6%, you'd want lumber at a maximum MC of 10% before finishing. Using the Decay Hazard Index

2.5.5 Controlling Air Leakage

Map in Figure 30 as a rough indicator of EMC, the following upper limits for lumber moisture before finishing occurs can be used as approximate targets:

- Decay Index ≤ 20 , Maximum Lumber MC at finish installation = 10%
- Decay Index 20 to 70, Maximum Lumber MC at finish install = 12%
- Decay Index ≥ 70 , Maximum Lumber MC at finish install = 15%

These regional values are estimates. You can gain a better feel for the relationship between lumber MC and the durability of finishes by checking moisture levels on actual sites. Moisture meters, which cost \$100 and higher, can be used for this purpose.

Properly Size Cooling Equipment to Improve Water Vapor Removal

Cooling systems should be properly sized based on the home's construction characteristics and the local climate to reduce short-cycling and thereby improve the ability of the system to extract moisture from indoor air. Basic tools for proper cooling system sizing are discussed in Section 2.5.7.

Educate Occupants on the RH Impacts of Homeowner Habits

Homeowners should be educated on how their habits, such as the use of exhaust fans or humidifiers, can have major effects on indoor humidity levels. Basic homeowner education information is provided in Section 4 of this guide.

REFERENCES AND ADDITIONAL RESOURCES:

Storage and Handling of APA Trademarked Panels. Form No. U450D. APA - The Engineered Wood Association, Tacoma WA, 2002, www.apawood.org

Storage, Handling, and Safety Recommendations for APA Performance Rated I-Joists. Form No. Z735. APA - The Engineered Wood Association, Tacoma WA, 2000, www.apawood.org

Wood Handbook – Wood as an Engineering Material. U.S. Department of Agriculture, Forest Products Laboratory, 1999, www.fpl.fs.fed.us

2.5.5 Controlling Air Leakage

OBJECTIVES: Air leakage through building assemblies can move large quantities of water vapor and is a major factor in many vapor-related moisture problems. Building envelopes should be designed and constructed to reduce air leakage from inside to outside (cold climates) or outside to inside (hot-humid climates). To achieve this objective, the big leaks in the building's envelope must be sealed. In addition, a suitable air barrier system should be carefully considered and employed. Air leakage is driven by any one or a combination of the following: wind, stack-effect, and forced-air HVAC equipment like the central air handler. Wind and stack effect-driven air-leakage are best handled by use of air barriers as recommended in this section, and HVAC issues are addressed in Section 2.5.7.

PRECAUTIONS: There are a few precautions worth mentioning when "tightening" the building envelope. First, the use of air barriers and air-leakage sealing practices can reduce the supply of combustion air for fossil fuel-fired equipment (e.g., oil or gas furnaces, gas water heaters, gas dryers, etc.) located within the conditioned space. This can result in negative pressures and back-drafting of combustion products. The operation of spot exhaust fans (e.g., kitchen or bath), whole house exhaust ventilation, or even the stack effect can also cause depressurization of the indoor space near

combustion equipment, leading to back-drafting and introduction of combustion products, such as carbon monoxide, into the home. Because of these health and safety concerns, sealed combustion equipment is recommended as a best practice in Section 2.5.7.

Second, mechanical ventilation may be required or recommended to address other consequences of tightening the building envelope, such as IAQ and humidity control. For example, modern residential building codes still permit the use of operable windows as means of providing fresh-air ventilation (though this has been hotly contested in recent years); however, it may be increasingly risky to rely solely on occupant behavior to provide adequate ventilation in this manner in the absence of higher levels of natural ventilation.

As a final precaution, *air barrier materials must also be considered in terms of their impacts on vapor movement and water shedding*. For instance, if an air barrier is used on the exterior of the wall as a weather barrier underneath cladding (e.g. house wrap) it must have adequate water-resistant qualities. And if an air barrier is used on the inside of a wall in a hot/humid climate, it needs to be a permeable material and not one that will prevent vapor from drying to the inside.

BEST PRACTICES:

Seal the Big Air Leaks

To ensure that an air barrier functions as intended, leaks in the building envelope and air barrier system must be reasonably controlled. The methods are generally “low tech” and common sense oriented. Current building codes require air sealing around the following types of areas: framing joints around windows, doors, and skylights; utility

Why attempt to control air leakage?

- Because the pros outweigh the cons.

First, airflow can transfer moisture vapor through and into building assemblies in amounts 10 to 100 times more than that which would typically occur by vapor diffusion. Significant air leaks – from a bathroom into a cold attic for example – can deposit large amounts of moisture vapor on cool surfaces and create condensation and water accumulation that damage building materials and make some insulation materials ineffective. Without reasonable air-leakage control, the use of vapor barriers is of limited benefit. Similarly, attempts to pressurize a building in a hot/humid climate (to control against the intrusion of outdoor humidity) or depressurize a building in a cold climate are far more effective with a tighter building shell (refer to Section 2.5.6).

Admittedly, some amount of natural air leakage under the right climate conditions can be a good thing. Under ideal conditions that may occur during some periods of a year, it can help to dry building assemblies. Air leakage in the form of intended ventilation in attics and crawlspaces (outside of the building’s thermal envelope) is an accepted means of reducing moisture and is effective in many climates. Air leakage through the thermal envelope can also allow for uncontrolled “natural ventilation” of the building for indoor air quality.

However, the benefits of air infiltration through a building’s thermal envelope are either undependable or risky in many climates. Therefore, dependence on excessive or uncontrolled air leakage through modern building thermal envelope systems is generally discouraged. And in fact, modern model building and energy codes usually require fairly extensive practices to prevent the uncontrolled leakage of air through a building’s thermal envelope.

2.5.5 Controlling Air Leakage

penetrations; drop ceilings adjacent to the thermal envelope; wall cavities and chases that extend into unconditioned space; walls and ceiling separating an attached garage from conditioned space; openings behind tub and shower enclosures on exterior walls; common walls between dwelling units; and other sources of air leakage. Sealing materials include acceptable air barrier materials and durable caulks, sealants, tapes, and gaskets as appropriate.

The above list is exhaustive – all obvious air-leakage pathways are required to be mitigated. Yet, practicality suggests that ***the major focus should be on the “big leaks.” Big leakage points that should be air sealed include vertical mechanical chases, attic access hatches or pull-down ladders, floor overhangs, openings behind tub/shower enclosures, plumbing stack penetrations, utility penetrations in walls, and any exposed wall cavities that open into adjacent to attic space.*** Major leakage points in a house are illustrated in Figure 32.

Sealing the locations mentioned above should involve products that are durable and compatible with the joined materials, especially around hot surfaces. Examples include high-quality caulks, construction adhesives, spray polyurethane foam, gaskets, sill sealers, tapes, and a number of specialty products such as gasketed electrical receptacles and switch boxes and ceiling light fixture boxes.

Give Special Attention to Air Sealing Cathedral Roofs

Cathedral roofs can hide roof water leaks or condensation, particularly if a vapor retarder like polyethylene sheeting is used on the ceiling side (something that should

only be considered in very cold climates). ***If cathedral roofs are used, the ceiling and penetrations through the ceiling should be carefully sealed to prevent air leakage. This may involve special air sealed light fixtures, use of caulks and sealants at all penetrations and joints, and avoidance of leaky ceiling systems like exposed tongue & groove boards.*** Leakage of humid indoor air into cold cathedral roof cavities has been a major cause of condensation and moisture problems in these types of roofs.

Use an Appropriate Air Barrier System

Reducing air leakage through the building envelope is a good practice regardless of where in the envelope it takes place. Air barrier systems are strategies to block air leaks at a certain point in the building assembly while also addressing other envelope concerns like rainwater protection and vapor retarders. This section outlines basic air barrier strategies and where they are appropriate to use.

Appropriate air barrier materials include some panel products, membranes, and other coatings that have a low air-permeability. Examples include gypsum wall board, spray polyurethane foams, wood structural panels, extruded polystyrene and polyisocyanurate foam boards, building wraps, and others. Seams and laps in these products must be sealed. Examples of products that may be considered too air permeable to serve as an air barrier include fiber-board, expanded polystyrene insulation (Type I), glass fiber insulation board, and tarred felt-paper.

There are basically four methods of providing an air barrier system. Two of these approaches place the air barrier on the inside of the thermal envelope and two place the barrier on the exterior, as shown below and in Figure 33.

2.5.5 Controlling Air Leakage

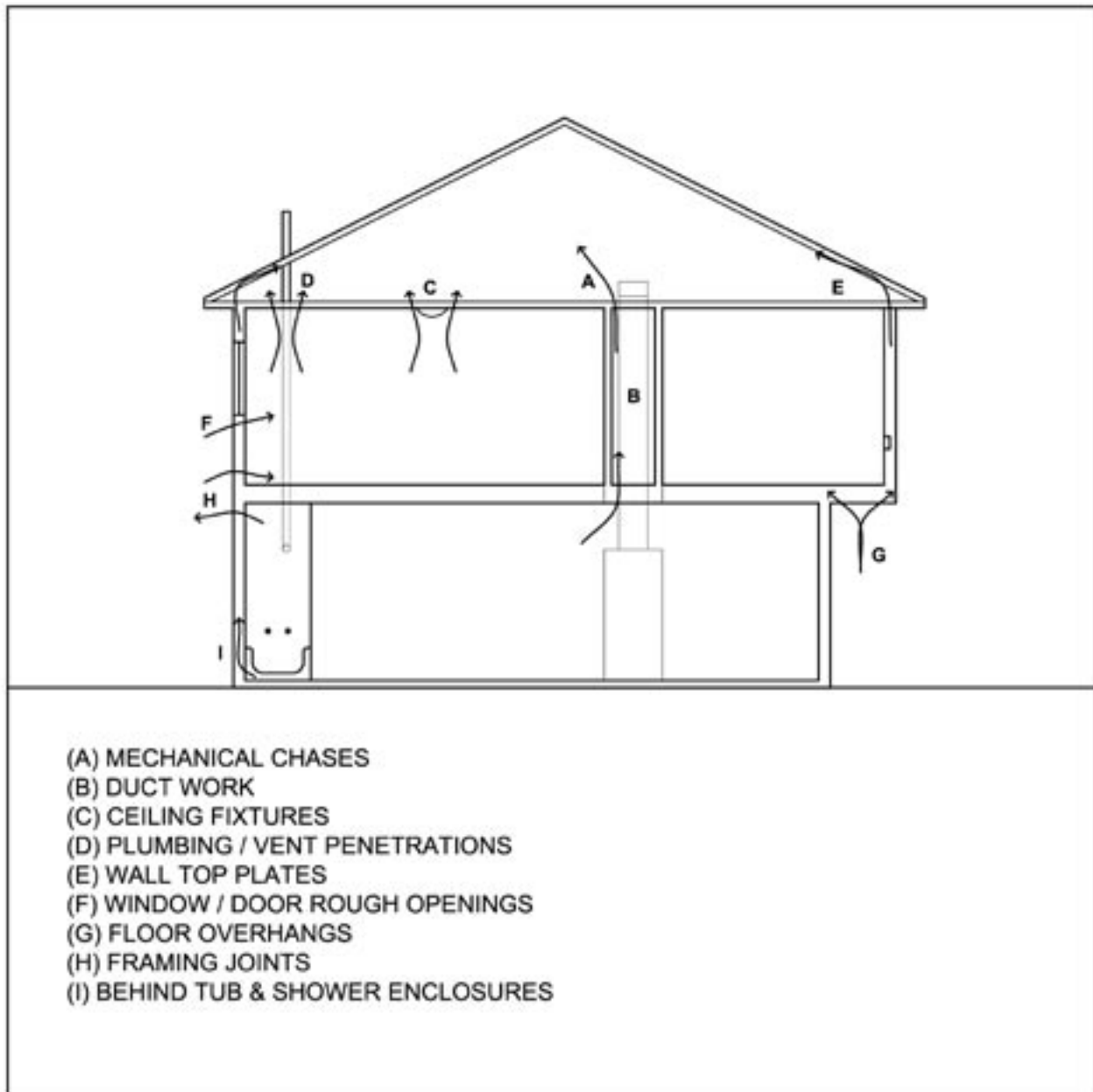

Figure 32 - Big Air Leakage Points to Seal

Interior Air barrier Methods

- Airtight Drywall Approach (ADA)
- Airtight Polyethylene Approach (APA)

Exterior Air barrier Methods

- Airtight Sheathing Approach (ASA)
- Airtight Wrap Approach (AWA)

In cold and very cold climates (see Figure 29), the primary concern is preventing interior warm and humid air from flowing outward into building exterior envelope assemblies in winter months. Such airflows can carry large amounts of moisture and cause condensation in the wall. **Therefore, the use of an interior air barrier system in cold and very cold climates is preferred and may be combined with a warm-in-winter vapor retarder.** A viable approach in such areas is the ADA method used in conjunction with an interior vapor retarder layer like kraft-faced batts or vapor barrier paint on drywall. Use of the APA method should be applied more cautiously, as some localities and building scientists are concerned that the poly layer is almost too airtight and vapor impermeable and will not allow drying to the interior of the building at any time of year.

In moist/humid climates (see Figure 30) the primary concern is preventing exterior warm-humid air from leaking inward through exterior surfaces into building envelope assemblies that will be cool from air-conditioning. **In moist/humid climates an air barrier system is preferred on the outside of the wall. Many exterior sheathing products and wraps can provide this function and also serve the water barrier function underneath siding materials (e.g., ASA and AWA methods).**

In climates with mixed conditions, the most suitable air barrier system can be selected based on other construction characteristics

and then combined with these systems. For example, if building wrap is used as part of a drained cavity weather-resistant envelope (Section 2.3.1), then the Airtight Wrap Approach (AWA) can be used with a little extra detailing of the building wrap like taping the overlapped seams. Similarly, extra attention to sealing interior drywall joints and penetrations can make the Airtight Drywall Approach a reasonable strategy.

REFERENCES AND ADDITIONAL RESOURCES:

Best Practice Guide: Wood Frame Envelopes in the Coastal Climate of British Columbia, Canadian Mortgage and Housing Corporation, April 9 1997 (THIRD DRAFT), www.cmhc-schl.gc.ca

Durability by Design: A Guide for Residential Builders and Designers, U.S. Department of Housing and Urban Development, Washington DC, 2002, www.huduser.org

Blower Door Tests and Smoke Sticks – Useful Tools for Gauging Air-Leakage Control Practices

A blower door test to evaluate the effectiveness of air-leakage control strategy is useful for models that will be repetitively built or for quality control purposes on any home. Blower door testing can be conducted on a finished house, or alternatively on a house that is insulated, sealed, but with walls not yet closed-in. Testing at a pre-completion stage of construction will not provide a useful numerical result, but it can be very helpful for clearly observing where leakage in the envelope is occurring through the use of a smoke pencil device that indicates drafts. Blower door tests on a finished house may also be used to determine if supplemental ventilation may be necessary for indoor air quality purposes.

ILLUSTRATED BEST PRACTICE:

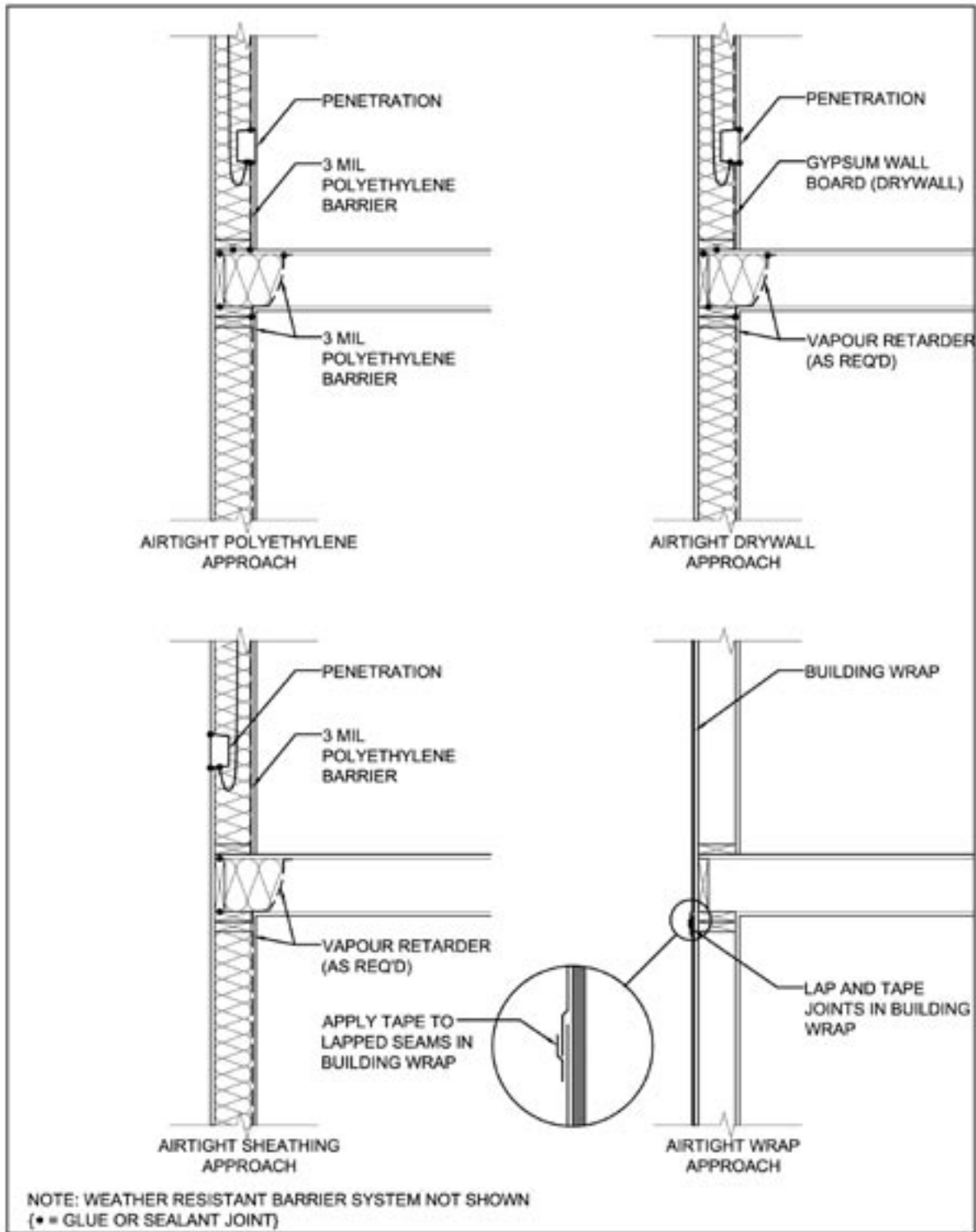

Figure 33 - Air Barrier System Approaches and Important Features

(Note: Any air barrier system should be used in addition to sealing the big leaks identified in the previous best practice)

2.5.6 Vapor Retarders

Field Performance of Whole-House Mechanical Ventilation Systems. U.S. Environmental Protection Agency Indoor Environments Division, November 2001

Fisette, Paul. *Housewraps, Felt Paper and Weather Penetration Barriers*, Building Materials and Wood Technology, University of Massachusetts, 2001, www.umass.edu/bmatwt/publications/articles/housewraps_feltpaper_weather_penetration_barriers.html

International Residential Code (IRC), International Code Council, Inc., 2003, www.iccsafe.org

Kerr, D., *Keeping Walls Dry*, Canadian Mortgage and Housing Corporation, November 2004, www.cmhc-schl.gc.ca

Scheffer, T.C. 1971. *A Climate Index for Estimating Potential for Decay in Wood Structures Above Ground*. *Forest Products Journal*, 21(10): 25-31

Verrall, A.F., and Amburgey, T.L. 1978. *Prevention and Control of Decay in Homes*. Prepared by Southern Forest Experiment Station, Gulfport, MS for U.S. Department of Housing and Urban Development, Washington DC

Woodframe Envelopes: Best Practice Guide, Canadian Mortgage and Housing Corporation, 2001, www.cmhc-schl.gc.ca

2.5.6 Vapor Retarders

OBJECTIVES: The movement of water vapor through vapor diffusion is another major factor of water vapor problems in houses, along with high indoor RH (Section 2.5.4) and air leakage (Section 2.5.5). The objective of this section is to provide best practice recommendations for the correct use of vapor retarders in the above-grade portion of a building's thermal envelope. The use of vapor retarders on foundation systems was addressed in Sections 2.4.2 through 2.4.6 due to the unique nature of foundation moisture exposure.

Making the Right Choice: Air barrier Approaches and Materials

The selection of an air barrier strategy and material should not be made without also considering the exterior weather barrier system (Section 2.3.1) and the appropriate use of vapor retarding materials (Section 2.5.6). The best choices will achieve all goals for the building envelope – (e.g., weather-resistant barrier, appropriate inner and outer vapor permeability, energy efficiency, structural performance, fire resistance, etc.) as well as cost-effectiveness. Because of the variety of considerations, many viable solutions are possible with consideration of local building codes and local material preferences.

Vapor retarders are used to control or slow the diffusion of moisture vapor through building envelope materials. Vapor retarders, when used correctly, prevent high levels of humidity inside building envelope assemblies that can result in condensation. **When used incorrectly, vapor retarders can trap moisture, slow the normal drying process, and contribute to moisture damage.** As mentioned in the previous section (2.5.5), air leakage is a more dominant type of water vapor movement, but vapor retarders also play an important role in an overall moisture control strategy.

PRECAUTIONS: All materials exhibit some amount of vapor retardance – that is – they have some impact on allowing moisture vapor to pass through them. So when considering vapor retarder requirements, it is important to consider the vapor permeability characteristics of **all** materials used in the wall assembly, not just those that are designated as a “vapor retarder.” References like the 2005 ASHRAE Fundamentals Handbook have permeance data that can give a sense of how breathable different types of construction materials are.

The recognition that all materials play some role in water vapor migration can lead to a host of complex design issues – especially as wall assemblies begin to include new or

2.5.6 Vapor Retarders

additional materials. A few examples of this are mentioned in this section, but these are specialized design issues that do not have a well established set of best practice guidance and thus are not discussed in detail here. More generic recommendations for vapor retarders are discussed here, and when followed in conjunction with the previous best practices for indoor RH and air leakage, should address the major causes of many water vapor problems in houses.

BEST PRACTICES:

Design Walls to Dry Towards the Inside in Hot/Humid Climates

In hot/humid climates exterior wall systems should dry towards the interior by locating vapor retarding materials on the outside of the wall assembly and keeping interior materials vapor permeable. Providing

some resistance to outdoor moisture vapor from diffusing into the wall assembly limits moisture problems during hot and humid periods of the year. And by keeping the interior side of the assembly vapor permeable, any moisture within the wall system can migrate to the cool and dry building interior. If a vapor retarding material like polyethylene or even vinyl wallpaper is used towards the inside of the wall assembly, it could block vapor migration on its cool surface and cause condensation problems. Instead, materials towards the interior of the wall assembly should be semi-permeable or permeable, like unfaced fiberglass batts with permeable interior paint on the gypsum. And while any practices related to vapor retarders and other wall assembly materials are subject to local code requirements, the moist/humid areas in Figure 30 give an indication of where drying to the interior is most important.

“Warm Walls” in Cold Climates – Current Building Science Research

For cold climates, some current building science research recommends avoiding the use of sheathing materials which are low perm and also of little insulating value (e.g., wood structural panels and similar sheathings) in climates with a substantial winter season. The concern is that the inside face of these materials will create cold surface during cold weather, and if humid indoor air enters the wall from air leakage or vapor diffusion it will condense on this surface. Condensation that does form in this manner would be unable to dry outwards through the sheathing since the sheathing is low perm.

Further, when an exterior insulating sheathing is used that also happens to be a low perm material, the available research and experience on such wall systems suggests that it should have enough R-value to keep its inside face from reaching a cold enough temperature to cause condensation for any significant period of time. This type of design may be called a “warm wall” approach. For this concept to work without creating a cold condensation surface internal to the wall, the exterior insulating sheathing must be thick enough to minimize the potential for its inside face to reach dew-point temperature given a reasonable winter design condition (e.g., indoor and outdoor temperature and humidity). Current building codes do not explicitly address this design approach to moisture vapor control in walls. Building energy codes generally recommend an R-value for insulating sheathing of approximately one-third of the required overall wall insulation R-value, including cavity insulation.

While this guide acknowledges current research in these areas, documentation of these issues and well established best practices are lacking standardized design and construction rules. Regardless, this method is frequently used with success in colder climates because of the condensation control provided by a properly executed “warm wall” design approach. Building science consultants or technical staff from manufacturers knowledgeable in this wall design approach should be consulted for additional guidance as needed.

In Hot/Humid Climates, Educate Homeowners of Problems with Using Non-Breathable Interior Finishes

In hot/humid regions, walls must be able to dry to the inside as discussed in the previous best practice. ***Homeowners in hot/humid regions must be educated not to limit the ability of walls to dry towards the interior by adding non-breathable interior finishes on exterior walls.*** Finishes that could compromise the wall's ability to dry inward include vinyl wallpaper finishes and vapor barrier paints.

Design Walls to Dry Towards the Outside in Cold Climates

In cold climates exterior wall systems should dry towards the outside by locating vapor retarding materials on the inside of the wall assembly and keeping exterior materials vapor permeable. Along with providing this type of wall design, control of indoor humidity levels (Section 2.5.4) and air leakage (Section 2.5.5) are also very important considerations. To establish resistance to moisture vapor diffusing into the wall from inside the house, widely accepted materials include kraft-faced insulation batts and semi-permeable interior paints. And while practices related to vapor retarders and other wall assembly materials are subject to local code requirements, the regions north of the condensation line in Figure 31 indicate areas where the ability to dry towards the exterior is important. As the climate becomes Cold (>6000 HDD) this issue becomes even more important, because longer and colder winter conditions will require walls that can dry outward and assemblies that limit indoor moisture from entering the wall.

Along with vapor retarder materials like kraft-faced batts towards the inside of cold region wall assemblies, vapor permeable materials towards the outside of the assembly will

facilitate outward drying. This allows any moisture in the wall to dry outward towards the colder and drier outdoor environment. However, several common sheathing materials like wood structural panels and foam insulating panels have fairly low perm ratings, which in theory could impede drying and possibly even create a cold surface for condensation (see text box). Given that this guide is intended to present established best practices and these issues are still being researched by the building science community, these design issues are referred to the additional resources in the References section.

REFERENCES AND ADDITIONAL RESOURCES:

APA – Build a Better Home, *Avoiding Moisture Accumulation in Walls*, www.apawood.org

Building Science Corporation, *Insulations, Sheathing and Vapor Retarders*, 2004, www.buildingscience.com

Durability by Design: A Guide for Residential Builders and Designers, U.S. Department of Housing and Urban Development, Washington DC, 2002, www.huduser.org

International Residential Code (IRC), International Code Council, Inc., 2003, www.iccsafe.org

U.S. Department of Energy. Building America Best Practices Series, Volumes 1-3, 2005. www.eere.energy.gov/buildings/building_america

2.5.7 Mechanical Systems

OBJECTIVES: This section presents moisture-control best practices for the planning, design, installation, and operation of mechanical systems such as heating/cooling equipment, ductwork, and ventilation. The best practices address common moisture issues that can arise from residential mechanical systems.

PRECAUTIONS: “Use a systems approach” - this is the mantra that builders and designers hear repeatedly. No single building system acts in isolation, and seemingly unrelated building systems can actually impact each other in very significant ways. At times this can begin to sound like jargon, but nowhere is it more relevant than when considering how the mechanical systems might impact the moisture performance of a house. And because some of these inter-relationships are not necessarily obvious, it’s important to work with designers and contractors that do recognize and understand the critical role of mechanical systems in managing moisture.

BEST PRACTICES:

Right-Size Cooling Equipment

Dating back to at least the 1958 edition of FHA’s Minimum Property Standards, residential building and energy codes have required that heating and cooling equipment sizes be based upon a recognized calculation method. Modern building and energy codes continue this requirement, and an ACCA Manual J analysis is considered to be the industry standard. ***Residential cooling systems should therefore be sized based upon a house-specific load calculation using Manual J or a comparable analysis and sizing tool.*** The specific orientation of the house should also be accounted for in this analysis, because a change in direction can result in a significantly different design load and equipment size.

Use Rules-of-Thumb Only for Preliminary Design and “Screening” Purposes

Commonplace rule-of-thumb sizing methods, such as 1 ton of cooling per 400 ft² of conditioned floor area, should not be used in the place of a building-specific load calculation method (e.g., Manual J) for reasons described in the text. However, if a

rule-of-thumb has any useful application, it is limited to preliminary design or perhaps as a quick means to determine if a particular A/C system design is potentially oversized. In this very limited application, a rule of thumb for hot/humid climates resulting from a 1999 FSEC research study is Cooling Capacity = ½ ton + 1 ton per 800 ft² of floor area served. Used as a screening tool, rules-of-thumb that reflect the regional climate and building practices can potentially help builders screen mechanical designs for oversizing.

Intentional oversizing of A/C systems or oversizing that results from rule-of-thumb methods causes increased short-cycling of the cooling equipment. Short-cycling reduces energy efficiency and can decrease the moisture vapor (latent heat) removal capability of conventional A/C equipment by as much as one-half of the rated latent heat removal capacity. This has two negative effects. First, indoor relative humidity levels are increased as the A/C system reduces the air temperature but removes moisture to a much lesser extent. Second, due to increased indoor humidity and discomfort, occupants may lower the thermostat set-point temperature to compensate. As a result of cooler indoor temperatures (e.g., less than 75°F) and higher indoor RH levels, condensation is more likely to occur on places like windows and doors, the inside of wall cavities, on concrete floor surfaces, and on floor sheathing and joists above crawlspaces.

For these reasons, this guide emphasizes the importance of using ACCA Manual J or other similar cooling load calculation procedures to size HVAC equipment.

Upgrade to Variable Capacity H/P or A/C to Improve Moisture Removal

Even *with* proper sizing of heat pumps for heating and cooling loads, there are

significant portions of the season where systems will operate under part-load conditions rather than design load conditions. Thus, accurate sizing of equipment only lessens the “short-cycling” problem. **To provide improved moisture removal and energy efficiency, 2-speed compressor heat pumps with variable speed blowers should be considered.** These systems operate on the lower capacity much of the time, providing enhanced moisture removal and more efficient operation. Such systems offer the greatest benefits in areas with long cooling seasons, and are also a good match for 2-zone systems because they can effectively handle single or dual-zone operation. A related best practice – Supplemental Dehumidification – is also explained below.

Provide Supplemental Dehumidification to Control Indoor Humidity in Moist/Humid Regions

Supplemental dehumidification – or enhanced moisture removal from HVAC equipment – is recommended in moist/humid regions (Figure 30) as a means to control indoor moisture levels. In other areas with less prolonged periods of high humidity, these systems should still be considered based on their benefits like better control of indoor moisture, enhanced comfort, and integration with fresh air ventilation. For new basement foundations, supplemental dehumidification will also help remove moisture from the foundation as it dries, which can help prevent moisture problems in finished basements.

“Supplemental” means some type of dehumidification equipment besides the house A/C system. These systems range in cost, quality, and function. A few dehumidification system options are discussed as follows:

- ***Portable Dehumidifiers*** – These are the simplest of supplemental dehumidifiers and generally provide adequate dehumidification for a small volume of air (e.g., one room or a small basement). They are relatively inexpensive and can include humidity sensors and controls which govern their operation. These units may require frequent attention to ensure that units are disposing of condensate properly (unless they are plumbed to a drain). They also give off waste heat into the area where they’re located.
- ***Stationary Dehumidifiers*** – These systems are available in a range of sizes for small and large jobs. These systems may be designed as a stand alone, single zone system, or may be incorporated into a forced air duct system. These systems, which also give off waste heat, have the advantage of a plumbed condensate drain that does not require frequent attention.
- ***Dehumidifier Ventilators*** – These systems are also stand alone systems to dehumidify air, but they also contain capabilities for fresh air ventilation and air filtering. The ability to introduce and dehumidify outdoor air with a single unit addresses the moisture that ventilation air can bring into a house, which is a major concern in hot/humid climates. Further, since dehumidifying ventilators are an independent piece of equipment, they can be used to control indoor humidity during shoulder seasons when the central A/C system does not run – another big issue in hot/humid climates.

Use Sealed Combustion HVAC Equipment

The use of sealed combustion HVAC equipment is recommended because it helps to alleviate potential back-drafting and it helps to control pressure differences across the building envelope.

Controlling air pressure differences across the building envelope helps to minimize air leakage and the migration of moisture into building assemblies. Sealed combustion equipment, like a sealed combustion natural gas furnace, draws all air for combustion directly from outdoors via a dedicated duct and combusts the air and fuel in a sealed combustion chamber.

Seal Ducts to Reduce Air Leakage and Moisture Movement

Building codes require that joints in duct systems be made “substantially” airtight by means of tapes, mastics, gaskets, or other approved methods.

This guide recommends sealing duct systems such that air leakage to outside (of the building envelope) is ≤ 5.0 CFM25/100 ft² of floor area served by the system.

“CFM25” is the air leakage from the duct system measured at a duct pressure of 25 Pascals.

Actual testing of duct systems with a “duct blaster” test can be conducted by home energy raters or utilities. Suitable sealing materials include UL 181-rated foil tape and mastic.

Sealing air leakage from ducts has two important advantages. First, it improves HVAC system energy efficiency and, second, it reduces pressure imbalances that can cause air leakage through the building envelope. This air leakage can transfer large amount of moisture into building assemblies and cause condensation and related problems. For example, a house with leaky supply ducts in the attic can become depressurized, resulting in warm-moist outdoor air being drawn into the building envelope during

the cooling season, a particularly troublesome problem in hot/humid climates.

Conversely, building pressurization (from leaky return ducts) can cause humid indoor air to exfiltrate into the thermal envelope where it may condensate on cold surfaces during winter conditions.

Provide Adequate Return Air Pathways

Most central return systems do not provide adequate pathways when interior doors are closed because door undercuts do not provide enough flow area for the return air. As a result, some interior spaces become pressurized and others are depressurized – both of which can drive air leakage and moisture transfer.

An ideal return air system provides unrestricted pathways for return air to travel to return grilles. Useful best practices to achieve this type of return system are:

- *Use multiple returns with the ducts formed from actual duct materials and not building cavities like joist bays (most expensive alternative, but most effective); or*
- *Use jumper ducts and transfer grilles to provide return air passageways from rooms that can be isolated when interior doors are closed (moderately effective and moderately expensive; may carry privacy objections).*

In addition to alleviating pressure imbalances and limiting air leakage through the building envelope, these practices can also improve comfort and eliminate carpet soiling problems which leave darkened stains on the perimeter of carpets.

TIP: Air Distribution System Commissioning

Building codes require and experts recommend that air-distribution systems (ductwork) be designed in accordance with accepted calculation methodologies (e.g., ACCA Manual D). This step gets you on the way to an efficient and well operating system, but as-built systems can often end up remarkably different from the planned design. This is true for both central heating and cooling systems as well as mechanical ventilation equipment. For this reason many experts also recommend commissioning air distribution systems in new residences. The process is fairly simple, but does require some specialized equipment and time. A typical air distribution system commissioning process in a house involves the following types of steps:

- Running the HVAC (or ventilation) system once the house is substantially complete
- Measuring flows at supply outlets and return grilles using a flow hood. If individual supply lines have dampers, flow levels can be adjusted to match the design
- Checking the pressure differentials between the central return zone and rooms with doors closed using a pressure gauge. A typical “acceptable” pressure difference between these zones is 5 Pascals
- Checking for correct operation of system controls like thermostats, humidistats, dampers, and timers (in the case of ventilation equipment)

The findings from these steps can be used to identify any performance issues and ensure that a system which costs thousands of dollars to purchase and install actually performs as intended.

Provide Whole-House Mechanical Ventilation

Whole-house mechanical ventilation systems are recommended to provide fresh air and help control a range of indoor air contaminants. Systems should be designed based on ASHRAE Standard 62.2 – Ventilation and Acceptable Indoor Air Quality in Low-Rise Residential Buildings.

A wide range of potential ventilation systems may be used, ranging from high-end equipment that introduces, filters, and dehumidifies outdoor air based on flexible controls all the way to basic, low-cost systems that simply run a duct from outdoors into the return-air plenum. Beyond sizing systems appropriately, a number of other design issues should be considered:

- ***For cold climates, consider ventilation systems that are balanced (air out = air in) or exhaust-based.*** By keeping the indoor environment at a neutral or slightly negative pressure relative to outdoors with these types of systems, moist indoor air is not forced outward into cold building assemblies where it can condense. However, ***it is critical that exhaust systems do not create negative pressure levels large enough to cause back-drafting or other combustion appliance safety concerns.***
- ***Ventilation systems in cold climates may also include systems with heat recovery.*** For example, a Heat Recovery Ventilator (HRV) exchanges heat from incoming cold

air with exhausting conditioned air for reasonably energy efficient ventilation. The incoming dry air also serves to control indoor humidity levels. Because an HRV matches the incoming and outgoing airflows, this type of system provides balanced ventilation.

- ***For moist/humid climates, consider supply ventilation systems which pressurize the indoor environment.*** This helps to prevent the infiltration of hot and moist outdoor air into building assemblies where it can condense.
- Another important feature of whole-house ventilation systems for hot and humid climates is accounting for the added moisture load introduced to the house. ***In such areas, the additional latent (moisture) load should be addressed either through direct dehumidification in the ventilation system or through the use of supplemental dehumidification.***
- Finally, ***testing and balancing of mechanical ventilation systems is also recommended – especially when contractors are first starting to install whole-house ventilation.*** Simple devices such as flow gauges can help to ensure that systems operate close to their design flow rates. In many cases, as-built installations achieve only half of the intended air flow and controls and timers may not be installed correctly. Building diagnostics firms or home energy raters can often provide this type of service.

Terminate Exhaust Ducts Outside and Provide Adequate Duct Runs

It is not uncommon to find clothes dryers vented to indoor or enclosed building

spaces like a crawlspace. It is also easy to find bathroom exhaust fans vented to an attic space or merely directed toward an attic vent. These practices are prone to create moisture vapor problems and should be avoided. ***Require all exhaust vents to be directly vented to the outside by attachment of exhaust vent ducting to appropriate through-wall or through-roof ventilation fixtures/grilles.*** Exhaust ventilation ducts should also be attached and supported like other ductwork. Finally, exhaust fans are rated (e.g., 50 cfm) based on a limited amount of backpressure due to type and length of ductwork and bends in ductwork. Therefore, ***duct lengths in excess of 25 feet (less 5 feet for each 90 degree bend) should be avoided unless appropriately designed. If long duct runs are unavoidable, larger capacity fan units should be used.***

REFERENCES AND ADDITIONAL RESOURCES

Air-Conditioning Contractors of America (ACCA), *Manual J – Residential Load Calculation*, www.acca.org

Air-Conditioning Contractors of America (ACCA), *Manual D – Residential Duct Systems*, www.acca.org

American Society of Heating, Refrigerating and Air-Conditioning Engineers (ASHRAE) Standard 62.2. *Ventilation and Acceptable Indoor Air Quality in Low-Rise Residential Buildings*, www.ashrae.org

Durability by Design: A Guide for Residential Builders and Designers, U.S. Department of Housing and Urban Development, Washington DC, 2002, www.huduser.org

Field Performance of Whole-House Mechanical Ventilation Systems. U.S. Environmental Protection Agency Indoor Environments Division. November 2001.

Home Ventilating Institute, www.hvi.org/

International Residential Code (IRC), International Code Council, Inc., 2003, www.iccsafe.org

Recommendations for the Prevention of Water Intrusion and Mold Prevention in Residential Construction. Texas Association of Builders, Builders Standards Initiatives, 2002

Vieira, Robin K., Parker, Danny S., Klongerbo, Jon F., Sonne, Jeffrey K., Cummings, Jo Ellen. 1996. *How Contractors Really Size Air Conditioning Systems*. Florida Solar Energy Center, Cocoa, FL, www.fsec.ucf.edu/bldg/pubs/ACsize/index.htm

PART III – CONSTRUCTION PHASE

This section of the guide offers tips on effectively *implementing* many of the best practices covered in Section II. Even with a well designed house and building plans that call out important details to manage water (the goals of Section II), job site quality management is critical. Often times, ***just a few minutes of oversight or inspection at the right point in the construction cycle is the difference between applying a best practice and a missed opportunity.*** And in many cases, once the opportunity to apply a best practice has passed it's very difficult and costly to address the issue later on.

Considering these simple quality management measures can help tremendously in avoiding jobsite moisture problems. Many of the recommendations in Table 12 below are also cross-referenced to the practices described in Section II for further background on a particular item. And as is the case throughout this entire guide, these recommendations are general guides that may be used in addition to other practices based on local experience and judgment.

Table 12 - Quality Management Recommendations

Phase of Construction	Quality Management Recommendation	Cross Reference
Plan Development	Develop Building Plans with Clear Details and Notes: Key moisture control details should be called out in building plans and be easily readable and understood.	
Contract Development	Reference Key Details and Specifications in Subcontracts: Contracts with subs should clearly identify material specs and details that are consistent with the building plans. Contracts should also address tasks that can fall through the cracks between different subcontractors - like insulating under a bay window or air sealing trunk duct penetrations - and identify who is responsible for these items.	
Pre-Construction	Hold a Pre-Construction Meeting with Key Subs: Meet with key subs (e.g., foundation, framers, insulators, siding crew, roofers) before construction with plans in hand. Point out and discuss key details to control moisture that are expected of different subs, and help subs understand their importance.	
Foundation	Ensure that Critical Slab Features are in Place Prior to Pouring: Prior to pouring slabs, check that poly, gravel beds, insulation, and reinforcement are installed as specified. Poly should be directly beneath the slab and be continuous and without tears.	p. 56 Section 2.4.4
Framing	Check Treated Lumber Certificates/Labels: When using preservative-treated wood, check that lumber with the specified level of treatment has been delivered.	p. 66 Section 2.4.8
Framing	Inspect Lumber Deliveries: Lumber shipments should be inspected for moisture to ensure that they comply with any applicable supplier agreements.	p. 74 Section 2.5.4
Framing	Protection of Moisture Sensitive Materials: Check for proper storage of framing materials on site and establish good storage practices as soon as materials arrive on site	p. 74 Section 2.5.4
Framing & Installation of Weather Barrier	Check Key Features of the Weather-Resistant Envelope before Siding Installation: The key features of the building envelope designed to hold moisture out – like shingle-style, lapped seams on house wrap or the integration of a weather barrier with flashing details at windows/doors – need to be checked before siding is applied and covers up these details.	p. 24 Section 2.3.1
Window & Door Installation	Inspect Window/Door Installation Procedures: Because penetrations in the building envelope are a common cause of water problems, periodic inspections of window and door installations and flashing measures should be conducted. Ensure that the flashing you specify is being put into practice, and identify any training needs.	p. 32 Section 2.3.2 p. 36 Section 2.3.3
Window Installation	Verify Window Ratings from Product Labels and Certifications: Window ratings for wind pressure and impact-resistance (if applicable) should be periodically checked on site.	p. 32 Section 2.3.2
Prior to Foundation Backfill	Inspect the Foundation Walls for Waterproofing and Unsealed Penetrations: Prior to backfill, the foundation walls should be inspected for waterproofing to specifications and for penetrations due to voids or other problem areas (such as form ties). Voids in the waterproofing should be appropriately repaired and sealed to create a waterproof face.	p. 48 Section 2.4.2
Foundation Backfill	Inspect Backfill and Grading for Compliance with Plans: Proper backfill practices and finish grading are extremely important to keeping a foundation dry over the long term and should be inspected and checked against specifications.	p. 48 Section 2.4.2
Roofing – during or just after roof sheathing install	Inspect Roof Sheathing Installation in High Wind Areas: Because underlayment is sometimes installed by the framing contractor immediately after completion of roof sheathing, a timely inspection of the sheathing for proper fastening is critical.	p. 3 Section 2.2.1
Roofing – prior to underlayment	Verify Installation of Eave Ice Dam Flashing 24" beyond Exterior Wall: For regions prone to ice dams, periodically inspect for the presence of ice dam flashing and ensure that it extends 24" horizontally beyond the plane of the exterior wall.	p. 10 Section 2.2.2
HVAC Rough-In	Inspect Exhaust Ducts: Check that exhaust ducts are vented to outdoors and run in straight, direct lengths.	p. 84 Section 2.5.7
HVAC Rough-In	Inspect and/or Test the Central Duct System: Verify that the central duct system is sealed with adequate materials at all joints and test systems for duct leakage periodically to baseline performance.	p. 84 Section 2.5.7
HVAC Rough-In	Confirm Proper Ventilation System Operation: Operate the mechanical ventilation system to confirm that controls, dampers, and other features work as intended. Basic airflow measurements can also be conducted to verify flows.	p. 84 Section 2.5.7
Plumbing Rough-In	Ensure that Supplemental Dehumidification Equipment is Plumbed to a Drain: In cases where a permanent supplemental dehumidification system is used, verify that it can be plumbed to a water drain line	p. 84 Section 2.5.7
After Mechanical Rough-Ins	Verify Adequate Ground Cover in the Crawlspace: Once mechanicals are installed check that a continuous and lapped ground cover is installed in the crawlspace per specifications. The ground cover should not be torn.	p. 62 Section 2.4.6
Insulating & Air Sealing	Inspect Envelope Air Sealing Details: Quick visual inspections should be conducted to verify that major air leakage sites are being addressed. For additional quality control, blower door testing can be performed before building assemblies are closed-in to identify and address leakage points.	p. 76 Section 2.5.5
Insulating	Inspect Wall and Attic Insulation: Confirm that insulated areas are free of voids and points of compressed insulation. Also make sure that attic insulation does not cover eave vents and that cathedral ceilings are insulated as specified.	p. 76 Section 2.5.5
Insulating	Confirm Attic R-Values when Insulating for Ice Dam Protection: Verify attic insulation R-value, especially when insulating beyond local code requirements for enhanced ice dam protection.	p. 36 Section 2.3.3
Basement Finishing	Confirm Basement Finishes for Moisture Resistance: Verify that basement wall gypsum is not in direct contact with the slab and that insulation details meet specifications.	p. 53 Section 2.4.3
Finishing	Moisture Test Assemblies before Close-In and Finishing: Spot test wetted assemblies and other framing to minimize subsequent moisture problems or finish damages from differential shrinkage.	p. 74 Section 2.5.4
Occupancy	Provide Homeowners with Educational Materials on Moisture: As homeowners assume maintenance and operation of the home, it's critical for them to understand some moisture basics. Consider using the guidance in Section IV or comparable materials to make homeowners aware of moisture issues and their responsibilities.	p. 93 Section 4.0

PART IV – HOMEOWNER GUIDE TO WATER MANAGEMENT & DAMAGE PREVENTION

4.1 Introduction

Designing, building, and maintaining homes that manage moisture effectively is a process of making good decisions. While builders and designers provide most of the up-front decisions, like designing the roof system or specifying the foundation drainage details – ***over the long term the homeowner must understand basic moisture issues and make good decisions at the right times.***

This section provides homeowners with basic information to make these decisions and take the appropriate actions to keep their homes dry and comfortable.

There is already plenty of useful guidance for homeowners on what to do (or not do) regarding moisture. Builders, housing groups, insurance organizations, and government agencies all have produced credible guidance on this topic. Therefore, this guide does not reinvent the wheel but will instead rely on available guidance for homeowners. The guidance that follows in this section is based very closely on information from the Institute for Business & Home Safety (IBHS) publication “Is Your Home Protected From Water Damage.” IBHS (www.ibhs.org) is a nonprofit association that engages in communication, education, engineering and research.

Many tasks involved with inspecting and maintaining a house can involve risk, and the primary concern should always be the safety of the homeowner or home occupant. If you have any doubt about safety or your ability to perform a task, use a professional contractor. The information below contains suggestions and recommendations based on professional judgment, experience, and research and is intended to serve only as a guide. The authors and contributors of the information make no warranty, guarantee, or representation, expressed or implied, with respect to the accuracy, effectiveness, or usefulness of any information, method, or material in this document, nor assume any liability for the use of any information, methods, or materials disclosed herein or for damages arising from such use.

This guide includes homeowner recommendations that detail the quickest ways to spot common types of home moisture problems before they become dangerous and expensive. It describes what you can do to prevent moisture problems from developing. And, along the way, it also provides valuable tips, insight and practical advice.

4.2 Moisture Control Background for Homeowners

Water, in its many forms, is an ever-present fact-of-life if you are a homeowner. Households commonly use - and discard - hundreds of gallons of tap water on a daily basis. Torrents of rainwater must be successfully shed by the roof and walls during thunderstorms. Groundwater travels through the soil beneath the foundation. We control indoor humidity levels for maximum comfort. The house itself absorbs and releases moisture in the forms of condensation and water vapor.

When a well-built home is properly maintained water is a benefit and a pleasure. On the other hand, uncontrolled water in our homes can cause damage, expense and considerable inconvenience. It can lead to mold growth, rotting wood and structural damage. It can also lead to the loss of irreplaceable personal belongings.

How Your House Handles Water

Imagine your house as a living thing. It has multiple ways to resist, absorb and channel excess moisture, as needed, to maintain its well-being, comfort and safety.

It Repels Excess Water

The exterior surfaces of your house, from roof to foundation, make up its envelope or 'skin'. The skin is designed to shed or repel excess water. If it doesn't, expect trouble. When roof flashings, windows, foundation walls, and other building components are not properly maintained, rainwater will find its way into vulnerable parts of your house.

It Absorbs & Releases Excess Moisture

All houses must absorb and release moisture constantly, in order to maintain a healthy balance. If your house has 'breathing' problems, many types of moisture problems can develop. Trapped moisture - dampness that cannot be released, for one reason or another - is one of the primary causes of fungus and mold growth in a house. Fungi can literally 'eat' wood, causing decay, rot and, ultimately, structural damage. Trapped moisture in the walls can destroy the value of your insulation and raise heating and cooling costs. Wood that stays moist attracts carpenter ants and other insects that can accelerate structural problems.

It Transports Piped Water

Directly beneath the 'skin' of your house is a complex maze of pipes carrying fresh water into your house and drain lines to dispose of water after its use. There are dozens of pipe joints and specialized fittings throughout your house, any one of which can develop a leak and cause moisture damage.

It Needs a Firm, Dry Foundation

The best foundation is a dry foundation. A water-damaged foundation is extremely expensive to repair and can lead to damage in the rest of the house. Ground water, flood water, or even rainwater from a misdirected downspout, can undermine your foundation and cause settling cracks, wet floors and walls, and lead to conditions that can support the growth of undesirable bio-matter, including mold.

Frequent Causes of Moisture Damage

Unwanted water can intrude through cracks in the protective skin of your house. It can also accumulate from interior moisture sources.

4.2 Moisture Control Background for Homeowners

The most common causes of both types of moisture damage are included here.

Roof or Flashing Needs Repair

Roofing materials can wear out, break, rust, blow off, or otherwise fail and expose the roof deck and structural components beneath to moisture intrusion and damage.

Most leaks occur around penetrations through the roof, such as at a chimney, plumbing vent, exhaust fan or skylight. Flashings and sealant joints around these penetrations can crack, fail and leak. Intersections of roof surfaces with walls are also a common leakage point.

Old or defective shingles can curl and crack, allowing moisture intrusion. If old shingles aren't removed before new roof shingles are applied, it can reduce the life of the new roof. Chimney caps can crack allowing water into interior areas of the chimney.

Shingle edges can fail, forcing rainwater to accumulate between the roof and gutter.

Flat or low pitched roofs have unique maintenance needs and are susceptible to water problems because they may not drain as quickly as roofs with a steeper pitch.

Flat roof drains or scuppers can clog and hold water on the roof, increasing the risk, not only of a leak, but of a possible collapse of the entire roof under the weight of the water.

Gutter & Downspout Problems

Clogged gutters can force rainwater to travel up onto the roof under shingles, or to overflow and travel down the inside of the wall, or to overflow and collect at the home's foundation.

First floor gutters can overflow if second floor gutters have been mistakenly directed to drain into them.

An insufficient number of or undersized downspouts can cause gutters to overflow.

Downspouts that don't empty far enough away from foundation walls can lead to foundation wall damage and a wet basement.

Ice Dams

Inadequate attic insulation allows heat to escape from the house into the attic, which can turn rooftop snow into an ice-dam along the eaves. Ice dams frequently force moisture to back up under the roof shingles where it can drip into the attic or walls.

Clogged or frozen gutters can act like ice dams, pushing moisture up under the shingles and into the house.

Soffits and Fascias Are Damaged

Damaged soffits (horizontal surfaces under the eaves) can allow snow or rain to be blown into the attic, damaging the insulation, ceilings and walls.

Fascia boards (vertical roof trim sections) are damaged, allowing the moisture from rain and snow into the attic and atop interior walls.

Weep Holes Become Clogged

Weep holes, which are designed to allow moisture to escape from behind walls, can become blocked.

Weep holes can freeze, forcing moisture to back up inside the wall cavity.

Weep holes can become clogged with landscape mulch, soil or other material.

4.2 Moisture Control Background for Homeowners

Landscape Grade Changes Have Occurred

Recent landscape modifications may have resulted in water drainage back towards the foundation, rather than away from it.

A newly-built home lot may have been graded improperly, or the original foundation backfill may have settled over time, causing drainage problems.

Automatic sprinklers may be spraying water onto or too close to the foundation walls.

Window & Door Flashing or Seals Need Repair

Cracked, torn or damaged seals, weatherstripping, and flashing around windows or doors can allow windblown moisture to penetrate your house.

Improperly installed windows and doors can allow moisture into the wall.

Failed or worn weather-stripping can allow wind-driven rain to penetrate a closed window or door.

Groundwater or Rainwater Collects

Groundwater or misdirected rainwater collects during wet seasons along the foundation wall or beneath the floor or slab. Unless it is directed away from the structure by a sump pump or corrected drainage, this moisture can lead to mold growth, wall failure and other destructive moisture problems.

Plumbing Develops Slow or Catastrophic Leaks

Plumbing fixtures, including dishwashers, disposals, toilets, sinks, water heaters, showers, clothes washers, tubs and other enclosures, can have pipe joint or hose

attachment failures and develop leaks, or hoses can rupture.

Leaks inside walls may go undetected for some time and result in significant damage.

Kitchen appliances, such as a refrigerator, icemaker or dishwasher, develop water line leaks.

Metal piping can corrode internally, or be damaged externally.

Hanging heavy items from pipes can cause a leak or failure.

Drains can clog and cause water to back up into the house.

The water heater can have a slow leak or fail catastrophically, causing flooding.

Condensation Forms on Windows, Pipes & Inside Walls

Condensation on windows can, at a minimum, damage window sills and finishes. At worst it can damage walls and floors as well.

Condensation on un-insulated pipes can collect nearby or travel along a pipe, to accumulate far from the original source.

Condensation can form inside improperly-built walls, and lead to serious water damage and biological growth that are hidden from sight.

Heating & Air Conditioning Systems Need Maintenance

Lapses in regular maintenance can lead to moisture and comfort problems, ranging from clogged drain pans to iced-up cooling coils and mold within the system.

Failure to clean and service air conditioners regularly can lead to diminishing performance, higher operating costs and potential moisture problems.

Humidifiers can add too much moisture to a house, leading to dampness and mold.

Sump Pump Needs Maintenance or Replacement

Neglecting to test a sump pump routinely - especially if it is rarely used - can lead to severe water damage, especially when a heavy storm, snow melt, or flooding sends water against your home.

Overload of the sump pump, due to poor drainage elsewhere on the property, can lead to pump failure. Frequent sump operation can be a sign of excessive water buildup under the basement floor, due to poorly sloped landscaping, poor rain runoff, gutter back-flows and other problems.

Lack of a back-up sump pump, which can be quickly installed in the event the first pump fails, can lead to serious water damage and property loss. This is especially important if you rely heavily on your sump pump to maintain a dry basement, or if you live in an area of seasonally-high groundwater. Sump failure can cause extensive water damage and the loss of valuable personal belongings.

4.3 Moisture Problems: Prevention and Correction

An “ounce of prevention” can prevent “gallons” of potential water leaks and damage – and a regular maintenance program is the easiest way to protect your home and its contents. The following checklists, organized room-by-room, provide you with key early warning signs to help you prevent (or at least minimize) water-related problems and home damage.

4.3.1 What to Look for In the Kitchen

We use the kitchen so much it's easy to overlook the warning signs of excess moisture and impending water damage. Learn to keep an eye out for these all-too-common sources of moisture damage.

Under the Kitchen Sink

Under the sink is not just for storage and the trash can. It is often the starting point for many water-related problems. Dampness or musty odors are common signs of a leak.

Don't ignore a drip in the trap under the sink. It's a warning sign of potentially serious drain problems.

Don't allow a steady drip at a faucet to continue. Repair it promptly.

Are there moist or stained areas in or under the wall where the plumbing pipes penetrate?

Are there large holes in the wall with smaller pipes coming through? Fill these holes with appropriate foams, caulks and sealants.

4.3.1 What to Look for In the Kitchen

Is the floor beneath the plumbing penetrations soft or stained? If so, find and fix the leak immediately.

Around the Kitchen Sink

The kitchen sink is a high-traffic zone that sees more action than almost any place in the home.

If backsplash or sink seals are cracked or loose, have them fixed immediately.

If countertop tile or grout is cracked, broken or missing, it's not a minor issue. Fix it.

Under the Dishwasher

This workhorse appliance is often overlooked as a water damage risk.

If the dishwasher backs-up or overflows into the sink, there may be a clogged drain line.

Clean the drain line regularly.

If the dishwasher fails to completely empty after use, the main filter and drain may be clogged.

If you sometimes see a small trickle under the dishwasher, there could be a loose connection or leaking water hose. Check the connection. Tighten, repair and replace as needed.

Find a small leak in the dishwasher water supply hose? Replace it immediately.

Behind the Refrigerator

We rarely inspect behind the refrigerator. But a regular check-up will help prevent messy problems. NOTE: If the refrigerator has an icemaker, take care not to damage or

disconnect the supply line when moving the appliance.

Moisture behind the refrigerator is a big red flag. If you can't find the source of the problem and repair it yourself, call an appliance repair professional.

Don't ignore even a 'slight' leak or kink in the icemaker supply line. Replace it - fast.

If moldy "things" are growing underneath the refrigerator, clean them out.

Locate the source of any moisture under the refrigerator. Have the leak fixed.

If your model has a drain pan, check the pan periodically and keep it clean to prevent bacterial and other growths.

Beneath the Cooking Range

This is another seldom-seen corner of the kitchen. Empty and remove the bottom drawer to inspect beneath the stove. If you see signs of moisture or mold, clean the area well.

Locate the source of any moisture under the stove and make repairs as necessary.

Exhaust Fans and Filters

Fans and filters are small items that play a big role in moisture and mold management. Some fans merely filter and recirculated air, which does not reduce moisture from cooking.

Is the range exhaust filter caked and dirty? Clean or replace it to ensure that air can flow freely through the filter.

Is the exhaust fan covered with dust? Clean it and make sure it operates properly.

4.3.2 What to Look for In the Bathroom

If you have down-vented indoor grills, check the filters often. Keep them clean to ensure the free flow of air when needed.

Kitchen-Care Smart Tips

Remind yourself to treat all sinks with a drain opener and clean out the disposal drains on a regular basis.

Periodically inspect and clean the refrigerator coils and clean the floor under the refrigerator as part of your housekeeping routine. This also helps it operate more efficiently and saves money on utility bills.

Don't forget to use new hose washers and clamps when you replace the dishwasher hoses.

Periodically inspect, vacuum and clean beneath the stove to prevent accumulation of dust, dirt and food particles. You don't have to move the stove to do this. Just remove the bottom drawer. A flashlight is helpful.

Make it a habit to inspect under the sink periodically. Look for any drips from the traps or supply lines, or early signs of moisture stains on the back wall or near plumbing penetrations. Smell for musty odors.

4.3.2 What to Look for in the Bathroom

Here are some regular bathroom checkup tips to help prevent moisture or mildew problems:

Plumbing

Most plumbing is hidden in the walls and serious problems can begin invisibly.

If you hear tiny drips in the wall, take immediate action.

If a wall is moist to the touch or discolored, there is moisture damage in progress. Get professional help quickly.

If a wall in an adjoining room is moist to the touch, there is a growing moisture problem that needs prompt investigation and repair.

Any visible leaks under the sink or around the toilet need to be fixed before they lead to more serious and expensive moisture damage.

Signs of water damage in flooring in the bathroom or on the ceilings of rooms below a bathroom are a red flag of a possible water leak. Don't ignore it.

Exhaust Fan

One of the most important tools for moisture management in the bathroom is the exhaust fan.

A nonfunctioning exhaust fan overloads the bathroom with damp air. Have it repaired right away.

If the exhaust fan doesn't come on automatically when the bathroom is in use, consider having the wiring changed so that it will. You can also use a switch that turns on the fan when the bathroom humidity is high, or use a timer switch that will operate the fan for 30 to 40 minutes after a shower.

If the area around the fan isn't clean and dry, or if dust or any sort of growth has accumulated on the blades or inside the exhaust duct, clean the fan and area well. Then double-check that the fan is operating properly.

4.3.3 What to Look for in the Utility Room

Be certain that the bathroom exhaust fan vents to the outdoors, not into the house or attic.

If the exterior vent dampers don't operate properly or don't seat well, have them fixed or replaced. If the exhaust duct is pinched or crushed, support the duct so that it runs as straight as possible. This helps the fan to move more air.

Toilet

The toilet has critical inlet and outlet functions that need to be sealed and leak free.

Make sure there are no water line leaks. Fix even small leaks immediately.

Check for signs of staining or water damage on the floor. If present, check the toilet rim seal and tank seal immediately. If the toilet rocks back and forth when pushed, the floor drain may not be sealed to the toilet."

If the floor around the toilet seems soft, structural damage may be occurring. Call a professional.

Windows

Bathroom windows need to perform properly in a wide range of humidity and temperature conditions.

If there are any obvious breaks in the weather-stripping or seals, repair them.

Malfunctioning locks and closure mechanisms should not be ignored.

If there are stains or flaking on the painted surfaces, they need to be resealed with a fresh coat of sealer and paint.

Showers and Bathtubs

Areas that are exposed to this much water need close attention to prevent problems.

If the caulking is cracked, stiff, or loose in spots, replace it immediately.

Cracked tiles or missing grout can channel water to vulnerable areas and need prompt repair.

If some water remains in the bathtub after draining, it is a warning sign of possible structural weakening in the floor beneath the tub. Call a professional immediately.

Bathroom Smart Tips

Check the ceiling of rooms under bathrooms, the kitchen or laundry area for signs of mold, staining or other indications of uncontrolled moisture.

Check the supply lines and drain traps under the sink monthly for any signs of small leaks.

Treat all bathroom drains monthly to prevent the buildup of hair and other potential clogs.

Always turn on the exhaust fan while showering to prevent excess moisture build-up. Let the fan run for several minutes after showering.

4.3.3 What to Look for in the Utility Room

Your water heater and heating, ventilating, and cooling system (HVAC) can be located anywhere, from the attic to the basement, or in a utility room. Regardless of the location, here are the periodic checks you can perform to help reduce the potential for moisture damage and unwelcome growth in these important systems.

4.3.3 What to Look for in the Utility Room

Water Heater

The tank should be clean and rust free. If you find rust developing, it is often a sign of imminent tank failure. Have it checked immediately and, if necessary, replace the old water heater.

If you find tiny leaks at the inlet or outlet pipes turn off the water and power supply and have repairs made immediately.

The area around the tank should be clean and dry. If you find signs of dampness, investigate immediately. Early detection of a small leak can help prevent far more serious damage if the tank ruptures.

The bottom drain valve should be dry and rust free. If you see rust, check for leaks around the valve.

If the tank is gas-fired, confirm that the exhaust vent and shield are in place and functioning properly. Call a professional if you suspect any problem, as malfunctioning water heater units can cause life-threatening conditions.

Water Softener

The area around the tank should be clean and dry. If there are signs of moisture, check for leaks and have any needed repairs made without delay.

Heating Systems

If your furnace burns oil or gas products, proper ventilation of combustion gasses is essential. Call a professional if you suspect any problem, as malfunctioning heater systems can cause life-threatening conditions.

Because most gas heating systems also generate water during combustion, proper

ventilation and periodic maintenance of your furnace will help ensure that the water is properly vented or drained away.

Change your HVAC system filters monthly in order to help reduce dust and pollutants in the home and limit any sort of growth that might start there.

Check that all through-the-wall penetrations for fuel lines, ducts, and electrical systems are well sealed.

All ducts should be clean and dust free. Inspect the air supply registers in the house for dust accumulation. If you see an accumulation of dust, check and replace the filter as necessary.

Duct installation and sealing ducts in unconditioned spaces, such as an attic or crawlspace, should be insulated. Gaps and holes should also be sealed with foil-backed tape or mastic.

Cooling Systems

Filters, supply lines, exterior wall penetrations, vents, ductwork and drainage systems must all be in good working order to avoid moisture problems.

Regularly check and clean the cooling drainage pan. The drainage pan operation is very important because water removal is a key element of cooling system operation.

At season switchover, remove dust and particulates that may have settled in the drainage pan over the winter. Pour some hot water with a few tablespoons of bleach down the drain to help clean out the drainage line.

When replacing the filter on your air conditioner, take time to look at the heat exchanger as well. If it looks dusty or rusty,

4.3.3 What to Look for in the Utility Room

take a soft brush and vacuum the surface of the heat exchanger. If it is rusty or caked, call an HVAC professional.

If your air conditioner coils “ice up” or if the A/C runs all the time, it can be a sign of several problems. Besides not working properly, these issues can also cause water accumulation and mold within the system. Call your local air conditioning service contractor for a system check-up.

Other HVAC Systems

Whole house fans, humidifiers, dehumidifiers, evaporative coolers, radon systems, and other indoor air quality systems need periodic check-ups.

Be sure that your dehumidifier does not have a clogged drain. Clean the cooling coils regularly.

Through-the-roof penetrations require careful attention to prevent water damage. Radon and HVAC systems, attic fans and whole house fans must be checked periodically to confirm that flashings and sealants remain in good condition. Check framing and sheathing around these penetrations for signs of staining or water intrusion. If you can see daylight, you can be certain there is a problem.

Through-the-wall penetrations should be handled with as much care as through-the-roof penetrations. Electrical, plumbing, HVAC, communications, home security, cable, exhaust vents and pet doors can become sources of serious moisture intrusion. Inspect them regularly.

Check the filters, watering pad, reservoir, pump and water connections of an evaporative cooler twice each month during

the operating season. Hard water can damage these systems. Annual reservoir demineralizing treatments and pad replacement are important.

Check the water connections and clean the evaporator pad of a whole house humidifier monthly. Replace the pads at the end of each heating season to prevent unwanted biological growth.

Utility Room Smart Tips

Carbon monoxide detectors are one way to help in early detection of combustion gas problems.

You’ll save money on your utility bills if the heat exchanger and cooling coils in your air conditioner and heat pumps are clean and dust free. Use the soft attachment of the vacuum cleaner to clean heat exchanger and cooling coil surfaces regularly to reduce the potential for molds and other biological growths. Change the main system filter(s) monthly.

Monthly replacement of HVAC filters saves money on your heating and cooling costs as well as reducing the potential of moisture related growth.

Keeping all ductwork well taped and sealed is still another way to achieve home energy cost savings.

At the time of seasonal switchover, clean any drains that do not flow freely. Vacuum first, and then flush with hot water and a few tablespoons of bleach.

Kitchen, bath and other exhaust fans should be cleaned of dirt and debris (such as bird nests) regularly, from indoors and outdoors. While you’re doing that, it’s a good idea to

oil the damper hinges and confirm that the damper closes completely.

Wall penetrations for the heating and cooling systems should all be well sealed and insulated.

4.3.4 What to Look for in the Attic

Make it a habit to conduct this brief inspection every time you go to the attic. If you are unable to inspect your roof easily, the attic will be one of the first locations where roof-related problems will be evident.

Look Up!

Roof Pass-Throughs

Inspect each location at which something passes through the roof. These typically include chimneys, plumbing vent pipes, skylight wells, radon vents, etc. If any of the following warning signs are present, consult a qualified contractor immediately.

Does anything appear wet? Are there stains on the wood – a tell-tale sign of previous leaks? Is it still moist or cool to the touch?

Is there a damp or musty smell?

Are there any visible signs of mold or rot?

Can you see daylight through cracks?

Attic Vents

In most houses, vents are near the gables, eaves, at the soffits or along the peak of the roof. Proper attic ventilation is very important.

Is the wood and insulation near the vents dry? That's a good sign. Moisture or surface discoloration is a warning sign.

Check that all vents are well attached to the walls and roof and are not loose.

Remove any bird nests, insulation or debris blocking the vents.

Look Down!

Be sure to look down, as well as up, when checking for moisture damage in the attic.

Insulation

Is the insulation still looking soft and fluffy? Is it thick? These are good signs.

If there are areas that look unusually thin or flattened, it could be a sign of moisture damage. Feel the area. If it is wet, you have a problem that needs to be fixed quickly.

If insulation near the eaves and soffits is not as fluffy and thick as it is near the middle, it could be a sign of a damaged soffit or other perimeter leak. Be sure the insulation does not cover soffit vents. Air needs to be able to flow through the vents.

Examine ceiling penetrations coming up from the space below like plumbing vent stacks and ducts. These penetrations should be sealed against air leakage with appropriate materials.

HVAC Systems in the Attic

Attic HVAC systems and ductwork can be a source for unwanted moisture intrusion.

Inspect the ductwork. If duct joints are exposed or not well-sealed, make repairs.

If the insulation surrounding the ductwork is deteriorating, replace it.

4.3.5 What to Look for in the Basement

See more information on HVAC systems in the Utility Room section.

Recessed Lights

You can often spot good clues for the presence of excessive attic moisture around these fixtures.

Inspect all lighting canisters. If the canisters show rust or corrosion, it could be a warning sign of a potential electrical hazard in addition to possible moisture intrusion.

Consider having a professional replace your older recessed ‘cans’ with newer, safer ones that are insulated.

If the wood and insulation around the canisters is stained or shows color differences, it is a clear sign of unwanted moisture. Check above and around these areas for sources of moisture.

Walls Connecting Attic to Basement

Interior partition walls that go from the attic to the basement are often used for electrical, plumbing and ductwork chases that can contain hidden moisture problems.

If insulation is missing in the middle of the attic, there may be unwanted airflow from the basement to the attic through an interior partition. Be sure to seal off and insulate these types of hidden channels to prevent air and moisture flow.

Attic Smart Tips

When checking or adding attic insulation, be sure that none of the soffit vents are covered or blocked.

Make attic checks routine in summer and winter. Many moisture problems are seasonal.

Don't ignore any attic stain. Stains near attic vents are signs of previous moisture intrusion through or around these vents. The cause should be investigated promptly, even if the area is currently dry.

Remember to treat an attic air conditioning drain exactly as you would any other household drain. Routine maintenance should include a periodic removal of dust and debris, and a hot water and bleach flush.

Squirrels, mice, bats, snakes and other animals often get into attics through small defects in soffits or vents. They can do additional damage that can lead to moisture problems, so be sure to repair any damaged areas promptly.

4.3.5 What to Look for in the Basement

Basements often contain a wide array of the plumbing, electrical, HVAC, communications, waste removal and other systems of your home, which means there are plenty of potential moisture problems. Here's what you should keep an eye on.

All Basements

Sometimes the clues found in the basement can lead to a leak in a bathroom, an attic or even a clogged gutter.

Look for water trails or stains on basement walls or on the floor above. Investigate the sources of all such stains or trails.

Water pipes can sweat and this condensation, left uncontrolled, can result in mold growth, mustiness, rust and rot. Look for pipes with beads of moisture on them. Does the water have a place to go? Insulating all pipes reduces condensation and saves on energy bills.

4.3.5 What to Look for in the Basement

If your heating and/or air conditioning system is in the basement, check the drain pans and filters. If the drain pan has collected dust and debris, or does not drain freely, clean and flush the drain. Replace the filters monthly.

Look at all HVAC ductwork. Repair any deteriorating tape, seals or insulation.

Inspect all overhead floor penetrations from drains and other systems. If there is any evidence of moisture around these penetrations or if they are not well sealed, locate the source of the moisture and make repairs.

Check all basement vents including the laundry, water heater and furnace vents and radon and bathroom exhaust fans for any signs of faulty operation. Vent failure is serious and should be repaired quickly by a professional.

Repair any deteriorating seals on openings through the basement walls, such as dryer vents, plumbing to the outside, exterior electrical outlets, phone and cable connections. If there are indications of water intrusion or any sort of growth, locate the source of moisture and make repairs.

Check the sump pump if you have one. If the pump frequently switches on and off, there may be excessive water buildup under the basement floor or slab. Locate the source of the water in order to reduce the load on the sump pump and lessen the risk of a more serious water problem.

In basements that are going to be finished for additional living space, any signs of moisture – whether they're continuous or only seasonal – must be addressed before you finish this space. The use of a supplemental dehumidifier in basements is a good idea if

the area is moist, and can also be used to help a new basement dry out over the first couple years of a new house.

Crawlspaces

Damp crawlspaces are likely places for unwanted moisture and mold growth.

Be sure that exterior grading does not slope toward the foundation walls. If so, make immediate grade corrections.

All crawlspaces should have a plastic groundcover to contract moisture from the ground and to prevent mold growth and structural damage.

Check all through-the-wall penetrations and HVAC ductwork for the same problems described above.

Unfinished Basements

Even these types of basements should remain dry.

If basement walls or floors are wet, investigate further. Find the moisture source.

If there is insulation on the walls or floors, inspect to be sure it is dry and in good condition.

Check the floor drain if there is one. Be sure that it drains freely.

Basement Smart Tips

Damp basements attract pests such as cockroaches, mice, snakes, etc., especially during the heat of summer. A basement should remain cool, dry and clean.

4.3.6 What to Look for in the Laundry Room

Do you rarely need the sump pump? In that case you should periodically test it to be sure that it will function properly when you really need it. Pour some water into the sump chamber and test to see if the float switch turns the motor on and that the pump drains the chamber.

If you rely heavily on your sump pump to maintain dry conditions in your basement, consider purchasing a back-up pump that can be quickly installed in the event that the first pump fails. Sump failure can cause extensive damage from an otherwise harmless rainstorm.

Buy a sump pump before the wet season begins. Home supply stores can run out of stock when numbers of area homeowners suddenly realize they need one.

If you live in a flood-prone area, a backup power supply system for the pump may be essential.

If you or a neighbor has made landscape modifications that have inadvertently diminished or destroyed good drainage, it could be one source of basement water problems.

4.3.6 What to Look for in the Laundry Room

The recurring warmth, moisture and dust of laundry rooms can invite all sorts of problems. Here are a few warning signs and regular maintenance steps you can take to avoid them.

Washing Machine Connections

Inspect for tiny leaks in the connections to both hot and cold water lines. Repair even the most 'minor' leak.

Check both ends of the water lines for possible leaks. Replace the small hose washers in the lines if they haven't been replaced recently.

Check for discharge hose kinks and cracks. If the hose is brittle or old, replace it.

Hard Water Problems

In areas with hard or mineral-laden water, if the washer is slow to fill, there's a good chance that the in-line filter is clogged. Turn off the water supply and remove the hoses. Remove the small wire filters from the washer inlets, or, if not removable, use an old toothbrush, cotton swab or shop vacuum to clean out the clogged filters.

Is there a steady drip into the washing machine? Grit has probably damaged the shut-off valve. Repair it yourself or call an appliance repair specialist.

Hoses & Filters

Inspect and periodically replace all types of hoses.

When replacing hoses, be sure to also install new hose washers.

Utility Sinks

If the utility sink drains sluggishly, take steps to remove the blockage.

Watch for any signs of dripping faucets, water damage to the flooring, or leaks in the drainpipe. Do not ignore even a small leak.

Dryer Connections

If the dryer vent hose isn't tightly connected to the outside vent, repair the clamp or re-tape to seal. Mechanical fasteners, such as

screws and clamps, are more effective than tape.

If dryer lint is accumulating behind and under the dryer, the vent pipe may be clogged. Check that it is free of debris, both from the inside and outside of the house.

If there are too many twists and turns in the line for the dryer to vent efficiently, make the exhaust more short and straight, taking care that it still terminates outside of the building.

Laundry Room Smart Tips

Give the utility sink periodic drain treatments to prevent clogs and promote free drainage.

If at all possible, connect the dryer hose in a straight line with the outdoor vent.

Metal dryer vent pipes are preferable to the plastic accordion types.

Hose clamps and good metal HVAC tape can help seal up a poorly connected dryer hose and eliminate excessive moisture and dust accumulation.

Make it a habit to vacuum around and behind the washer and dryer routinely.

Keep the laundry area clean. Dust and dirt combined with moisture can promote unwanted mold growth.

Remember to clean out the dryer lint trap after each load.

4.3.7 What to Look for Outside Your Home

To keep the exterior of your home a fortress against the elements, here's what to look for:

Exterior Sidings & Wall Penetrations

Are siding boards cracked or broken? Is the vinyl cracked? Is building paper or structural sheathing visible? Repair these damaged areas immediately.

Cracks in brick, stucco, stone or other masonry need further investigation of their cause.

Check and clean weep holes regularly to prevent trapped water behind walls.

Fix any damaged exterior hose bibs that have even slight leaks.

Any open or unsealed exterior wall penetrations, such as for wiring, plumbing, telephone, cable and HVAC lines should be re-sealed with appropriate caulk, foam or sealant.

If exhaust vent doors no longer close snugly against their gaskets, repair or replace.

Inspect seals along the wall openings around vents and other penetrations and replace or repair any that are loose.

Repair any exposed, unstained or unpainted wood surrounding wall penetrations.

Look for signs of termite infestation, or moisture intrusion from earlier termite damage.

Windows & Doors

Do the closed windows still show cracks between the sash and frame? Are they difficult to open and close? Clean and lubricate the operating mechanisms.

If window flashing is loose or damaged, have it repaired.

If the perimeter sealants are no longer pliable and continuous, reseal and caulk.

If there are signs of moisture accumulation above or under the windows, check all water management systems above the windows, including shingles, gutters, flashing, siding and soffit vents.

If doors no longer fit tightly or the locks don't hold the door tight against the seals, the doors may need to be adjusted for water damage prevention and security.

Has the weather-stripping between the window sash broken or worn away completely? These are vital to both water and air leakage prevention. Replace broken or worn weather stripping immediately.

Good Drainage

If the ground has settled or slopes toward the foundation, add dirt or re-grade to ensure that water drains away from the foundation walls. Don't pile new dirt closer than 6" to the bottom of siding.

If any downspouts discharge near the house, connect them to gutter drainpipe that discharges to a daylight opening at least 5 feet from the foundation wall.

Do the gutter drains slope toward the house? Make sure they slope away from the house.

Has the landscaping altered the water drainage? Landscape to promote positive drainage away from the foundation.

Does the driveway channel water toward the house? Re-grade or alter the drainage to carry driveway water away from the foundation.

Regular driveway maintenance can help prevent rainwater from seeping into the ground beneath the driveway and toward the house. Some driveways require resealing regularly to prevent cracking and sinking.

Trees

Tree roots or yard pests can clog drain lines to septic fields and other water management systems. Check periodically to determine if roots have invaded drains.

If any limbs are so close to the roof that they could be holding moisture against the shingles, have them trimmed or removed.

If tree limbs brush against the house or windows during high winds or thunderstorms, have them trimmed to prevent possible siding, shingle, gutter or window damage.

Exterior Smart Tips

Maintaining good weather-seals on your doors and windows translates into energy and money savings and reduced risk of water penetrations.

In a downspout-related water emergency, use lengths of inexpensive, flexible plastic downspout extensions to direct the water toward lower ground, far away from the house to protect the foundation walls.

Walk around the perimeter of your house during heavy rains to more easily see where

gutters, downspouts and drainage systems may not be performing adequately. This is the best time to observe problems so they can be corrected.

4.3.8 What to Look for on the Roof

Most of us have never been on a roof - and many roofs are not safe for homeowners to visit and inspect. The good news is that some warning signs can be seen from the ground, so make it a point to periodically look up at your roof. *If you can get onto your roof safely*, here's what to look for to reduce the risk of unwanted water intrusion and moisture damage.

Shingles

If the shingles are worn or curled or missing, it's time to repair the damaged areas.

If shingles are over 15 years old, it may be time to start getting estimates on a new roof. Check your literature for your roof's life expectancy.

If the gutters regularly fill up with shingle grit, it's a sign of rapid aging and should be investigated further.

On a tiled roof, any visibly cracked or missing tiles should be replaced or repaired.

With a wood shingle or shake roof, look for curled, deteriorated, or mossy shingles. Moss may be a sign of insufficient water drainage and should be inspected by a professional roofer. Have any damaged or missing shakes replaced.

Older rooftop antennas can literally drill holes in shingles. Check the foot of your antenna. Has the plate worn away? Is the shaft sitting directly on the shingle? If so, get a new

footplate and reseat the foot of the antenna. Repair any shingle damage that may have occurred already.

Flashings

On-the-roof inspections are best to assess flashing quality or damage, so you may need to call a professional roofer if you cannot easily and safely inspect your own roof.

If the chimney flashing doesn't appear smooth and intact, it needs closer inspection.

If the flashing and sealants have failed and there are obvious holes in the sheathing, or worst case, into the attic, call a professional immediately.

Confirm that the perimeter of any skylight is well flashed and sealed.

Check the shingles around the skylights. If any are curled and cracked, call a professional roofer.

Check the flashing and seals on all plumbing stack vents, chimneys, skylights or other roof penetrations. If you find cracks or gaps around these areas, re-flash and re-seal them as needed.

Gutters

Most gutter checks should be conducted from the safety of a ladder on the ground. But, if you can **safely** access your roof, take a quick look into the gutter.

If the shingle drip edge (the metal strip under the first course of shingles above the gutter) is damaged or missing, or if the shingle edges have cracked and fallen into the gutter, the edge needs prompt repair.

4.3.9 Dealing With Major Water Damage Events

If you can see an excessive amount of shingle grit or granules in the gutters, it is not only a sign of shingle aging, but the grit can also impede the flow of water out of the gutter. Hose or sweep out the gravel.

If your gutters frequently fill with leaves and twigs, consider purchasing gutter shields that allow water in, while keeping leaves and other debris out.

If there is standing water in the gutters, the slope of the gutter needs to be adjusted to ensure proper draining to the downspouts.

Membrane Roofs

Flat roofs can create serious water problems if not maintained carefully.

If you see standing water on the roof, have the roof inspected by a professional roofer without delay.

If roof drains are clogged, clean them immediately and make it a point to clean them more often.

If there are visible cracks in the membrane, patch them right away.

Inspect and repair any weak or damaged seals on through-the-roof penetrations.

Roof Smart Tips

You don't have to actually be on the roof to see large parts of it. Try looking at its various sections from the vantage points of different windows. Use binoculars for close-ups.

You may need to clean your gutters more frequently than only in the fall, especially if the debris that collects is more dirt-like and

decomposing. Gutter clogs can lead to severe problems, such as winter ice buildup and rainstorm overflows.

4.3.9 Dealing With Major Water Damage Events

Pipes burst. Toilets overflow. Water heaters fail abruptly. Natural disasters, like windstorms, floods and earthquakes, as well as hurricanes, tornadoes or fire, can occur with little or no warning. When a major or catastrophic water event occurs it's important to respond as quickly as possible, without jeopardizing your safety.

Why Fast Action Is Important

By taking immediate action you will:

Reduce the amount of damage and loss of personal belongings and household goods;

Mitigate the amount of rust, rot, mold and mildew that may develop;

Lower the likelihood that the water will lead to structural problems; and,

Increase your chances of salvaging usable materials from the site.

4.3.10 What To Do After a Natural Disaster

Your first priority during a natural disaster is to protect the occupants of your home. Take all appropriate precautions that are directed by your local emergency management officials. Then, address the issue of protecting your home and belongings.

4.3.10 What To Do After a Natural Disaster

After the threat of physical danger has passed you should begin - immediately - to assess the damage and take the following steps:

Ensure that it's safe to venture out of the home. If you've been evacuated to a shelter, be sure it is safe to return home.

Ensure that it is safe to use electrical power. Water and electricity are a dangerous combination.

Ensure that the natural gas sources are safely secured.

Make sure the home is structurally safe to enter or reoccupy.

Secure the building exterior to prevent further moisture intrusion. This can include boarding up broken windows, making temporary roof repairs, sealing cracks or tacking down plastic sheeting against open gaps in walls or roofs.

What To Do After Any Major Water Damage Event

Disconnect all electronics and electrical equipment in the room. Move them to a safe, dry location.

Stop the flow of water, if possible, by turning off the main water supply to the house.

Contact a plumber or water extraction company, if necessary, for assistance.

Remove as much standing water as possible from inside the home.

Begin to remove water-damaged materials immediately.

Ventilate the home to the best possible extent with fans and/or dehumidifiers.

Major Water Event Smart Tips

Carpets damaged with clean water can usually be cleaned and re-laid over new padding.

Carpets damaged with dirty water, such as sewer backup or river sediment, will probably need to be replaced.

Before hiring a water extraction company be sure to get an itemized estimate.

Place your furniture up on blocks during a major water event. It will help protect the furniture from the water, as well as protect the carpet against damage from wet upholstery dyes, wood and rust stains.

If you live in a house or area where wet basement problems are common, don't store heirlooms, family photos or important documents in the basement.

Your Insurance Company Can Help

In the aftermath of catastrophic water damage to the home, your insurance company will work closely with you to help file your claim quickly.

Contact your property insurance company immediately following the water damage event. The company, its agents, or adjusters will guide you through the process, using their knowledge and experience with many other policyholders that have faced similar problems and disasters.

Maintain close contact with your insurance company throughout the claim and repair period. Working cooperatively and quickly, you will be able file your claim and move forward to repair damages.

4.4 In Conclusion

This guide arms you with information that can significantly assist in the protection of your biggest investment – your home.

As you can tell by having looked through this handbook, simple observations and inspections can help protect against:

- the deterioration of your home's value
- personal property loss
- structural damage caused by water

Developing good home maintenance habits, taking quick action when water damage occurs, making timely repairs, and thoroughly removing excess moisture from your home will help minimize your repair costs and future moisture concerns. A well-constructed and well-maintained home will protect your family and belongings for a very long time.

Resources

Whether you plan to hire a contractor for necessary repairs or improvements, you plan to do work yourself, or you're just interested in learning more about home moisture management, there are a number of excellent resources available to you.

Consumer Directed Resources

We all want to live in and maintain healthy houses. The more you know, the better you'll feel.

HUD Healthy Homes

<http://170.97.67.13/offices/lead/hhi/consumer.cfm>

FEMA "Repairing Your Flooded Home"

www.fema.gov/hazards/floods/lib234.shtm

GLE Associates, Inc.

www.gleassociates.com/mold

Environmental Protection Agency

"A Brief Guide to Mold, Moisture and Your Home"

www.epa.gov/iaq

For Homeowners Working with Contractors

Want help checking out a contractor before hiring or having a home improvement contract reviewed; or learning what a good home improvement contract includes? Start here.

Smart Consumer Services

www.SmartConsumerServices.org

HUD USER
P.O. Box 23268
Washington, DC 20026-3268

Official Business
Penalty for Private Use \$300
Return Service Requested

FIRST-CLASS MAIL
POSTAGE & FEES PAID
HUD
PERMIT NO. G-795

MOISTURE-RESISTANT HOMES



April 2006